



# SuperLine

**Product Catalog**

**Dentium**  
For Dentists By Dentists

# Contents

<b>SuperLine</b>	SuperLine Characteristics	06
	SuperLine Color Coding by Diameter	07
	SuperLine Fixture	08
<b>Surgical Components</b>	Cover Screw	09
	GBR Healing Abutment	09
	Healing Abutment	10
	Scan Abutment	12
<b>Prosthetic Procedure 1</b>	Dual / Combi Abutment - Abutment Level Impression	13
	Combi Abutment	14
	Dual Abutment	15
	Abutment Level Impression Components	17
	Restorative Kit	18
<b>Prosthetic Procedure 2</b>	Dual / Custom / Milling / Angled / Direct-Casting / Metal-Casting / Temporary (Plastic & Ti) Abutment - Fixture Level Impression	19
	Fixture Level Impression Components	20
	Custom Abutment	22
	Milling Abutment	23
	Angled Abutment	25
	Direct-Casting Abutment	27
	Metal-Casting Abutment	27
	Ti-Temporary Abutment	28
	Plastic Temporary Abutment	28
	<b>Prosthetic Procedure 3</b>	Screw Abutment - Abutment Level Impression
Screw Abutment		30
Angled Screw Abutment		31
Screw Abutment Impression Components		32
<b>Prosthetic Procedure 4</b>	Overdenture Procedure - Positioner / Mini Ball / Magnetic Attachment	35
	Positioner	36
	Mini Ball Attachment	38
	Magnetic Attachment	39

## Instruments

Surgical Kit (Full)	41
Surgical Kit (Standard)	42
Surgical Kit (Short Implant)	43
Stopper Drill Kit	44
Drill Stopper Kit	45
Surgical Instrument	46
DASK	55
Sinus Bur Kit	56
DASK / Sinus Bur Kit	57
Osteotome Kit	58
Trephine Kit	59
Instrument	60
Pins & Screws	61
Prosthetic Kit	62
Planning Kit	63
Prosthetic and Laboratory Instrument	64
Help Kit	65
Polymer Guide Kit	66
Sinus Kit	67
Ridge Expander Kit	68
Implant Guide Kit	69
Digital Guide-Full Kit	70
Digital Guide-Simple Kit	71







## S.L.A. Surface

S.L.A. (Sandblasting with Large grits and Acid etching)

- Higher bone-to-implant contact
- Faster bone formation on the surface

*reference: Kim H., et. al. "The Biocompatibility of SLA-treated Titanium Implants" Biomed. Mater. 2008; 3(2):025011*

*In vivo test*





*SuperLine*

# SuperLine Characteristics

## Joint stability & Improved strength for zirconia crown

- Abutment material: Grade 4 ➔ Alloy

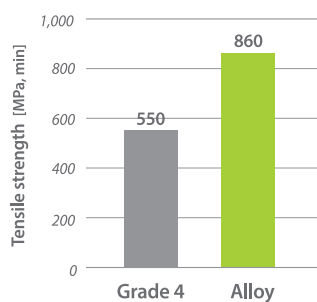

- Long hex design: Improved recognition

## Improved soft tissue management

- Concave abutment design
- Non-coating

## Improved wall thickness

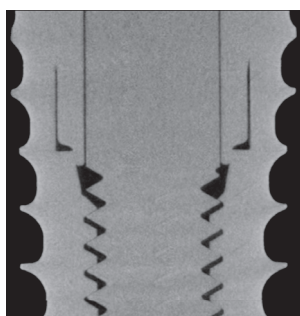

## Double thread & Tapered design



Double threaded tapered body design may provide better success rate in immediate loading cases.

reference: Kim et. al., "A Prospective, 1-year observational study of double-threaded tapered body dental implants with immediate loading" J Prosthet Dent 2015;114:46-51



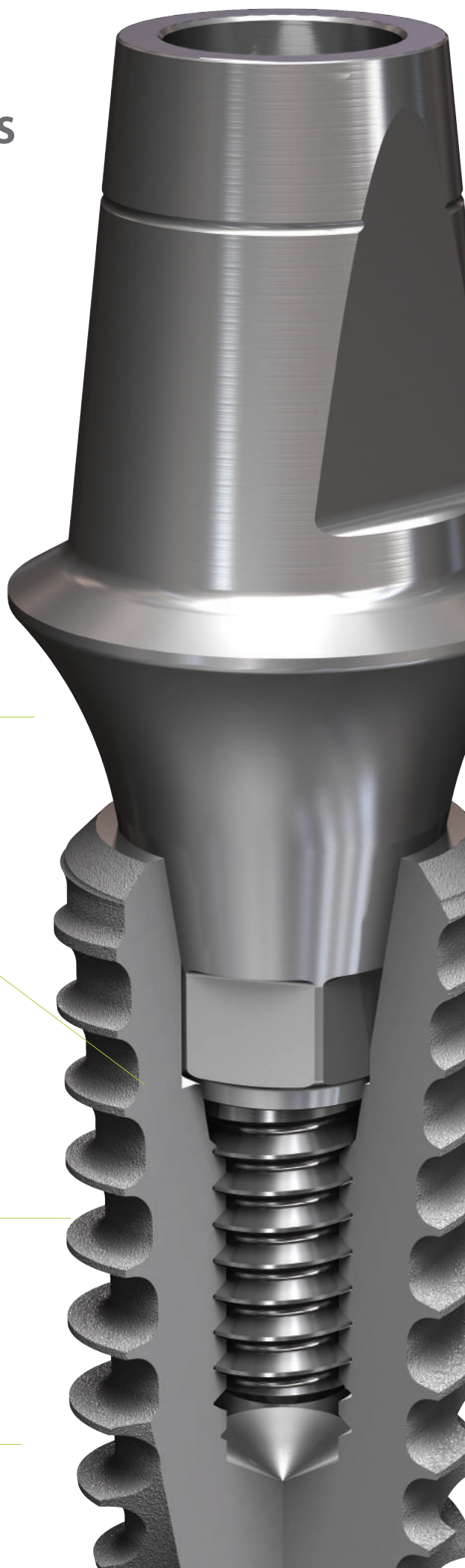





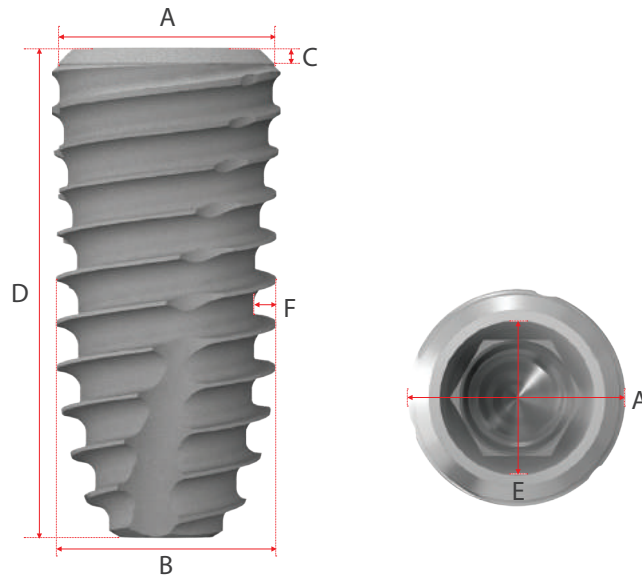



## Height and sharper thread design





# SuperLine Fixture Specifications



Fixture (Mount Free)								
<b>A</b>	Platform Diameter(Ø)	3.6	4.0	4.4	4.9	6.0	7.0	
<b>B</b>	Body Diameter(Ø)	3.6	4.0	4.5	5.0	5.0	5.8	
<b>C</b>	Bevel Height (mm)	<b>L: 7</b>	1.5	1.5	1.5	1.5	1.5	1.5
		<b>L: 8, 10, 12, 14</b>	0	0.1	0.3	0.4	0.7	1.0
<b>D</b>	Total Length(mm)	7, 8, 10, 12, 14						
<b>E</b>	Abutment Interface(Ø)	3.33	3.33	3.33	3.33	3.33	3.33	
<b>F</b>	Thread Depth(mm)	0.38	0.40	0.45	0.50	0.55	0.60	
Cap Color								
		Yellow	Green	Blue	Red	Orange	Violet	
Selection Guideline		Anterior	Anterior	Premolar	Molar	Molar	Molar	

# SuperLine Fixture

Unit: mm, Scale 1.5 : 1

· Cover screw is not included in the package

Platform	Body	L	Art. No.
Ø 3.6	Ø 3.6	7	FX 36 07 SW
		8	FX 36 08 SW
		10	FX 36 10 SW
		12	FX 36 12 SW
		14	FX 36 14 SW
Ø 4.0	Ø 4.0	7	FX 40 07 SW
		8	FX 40 08 SW
		10	FX 40 10 SW
		12	FX 40 12 SW
		14	FX 40 14 SW
Ø 4.4	Ø 4.5	7	FX 45 07 SW
		8	FX 45 08 SW
		10	FX 45 10 SW
		12	FX 45 12 SW
		14	FX 45 14 SW
Ø 4.9	Ø 5.0	7	FX 50 07 SW
		8	FX 50 08 SW
		10	FX 50 10 SW
		12	FX 50 12 SW
		14	FX 50 14 SW
Ø 6.0	Ø 5.0	7	FX 60 07 SW
		8	FX 60 08 SW
		10	FX 60 10 SW
		12	FX 60 12 SW
Ø 7.0	Ø 5.8	7	FX 70 07 SW
		8	FX 70 08 SW
		10	FX 70 10 SW
		12	FX 70 12 SW

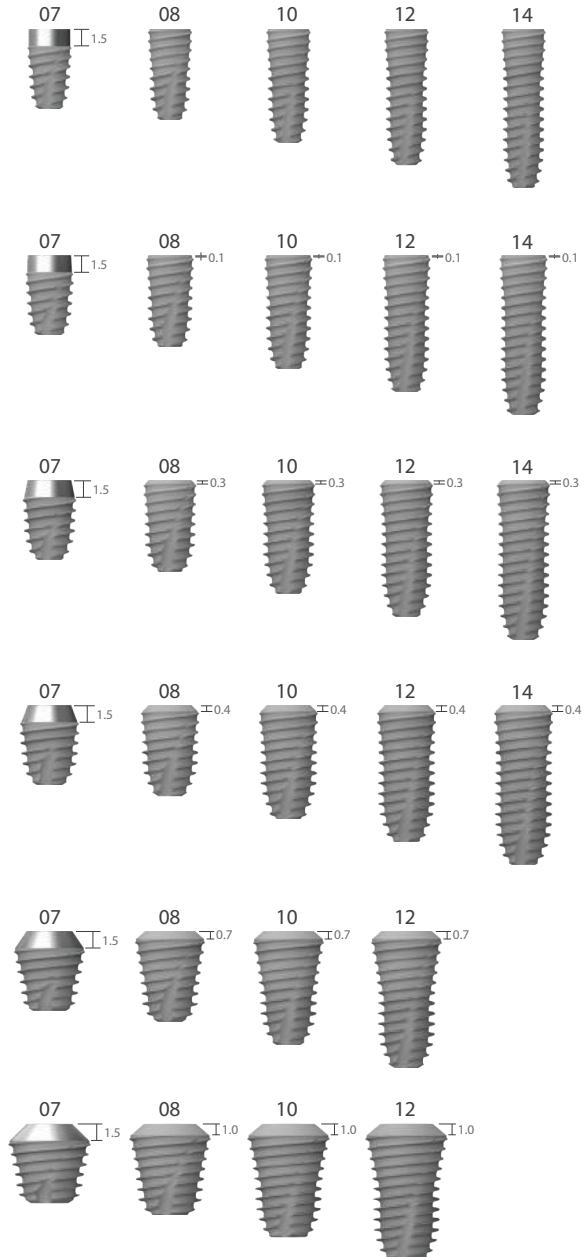

※ Note: To prevent damage to the Implant driver or fixture, do not over torque during fixture insertion.



# Cover Screw

Unit: mm, Scale 1.5 : 1

- Single use only
- Must sterilize prior to use

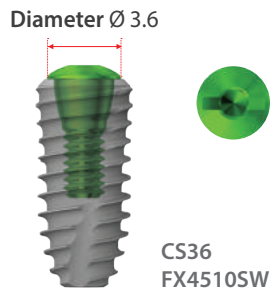

Color	Diameter	Art. No.
Green	Ø 3.6	CS 36

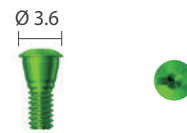

※ Hex driver: Use no more than 5N-cm of torque when screwing a cover screw to a fixture. If hex is worn, slot on the head of the product can be used to rotate it.

# GBR Healing Abutment

Unit: mm, Scale 1.5 : 1

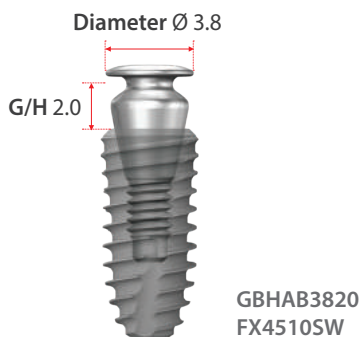

Diameter	G/H	Art. No.
Ø 3.3	3.5	GBHAB 33 35
Ø 3.8	0.5	GBHAB 38 05
Ø 3.8	2.0	GBHAB 38 20

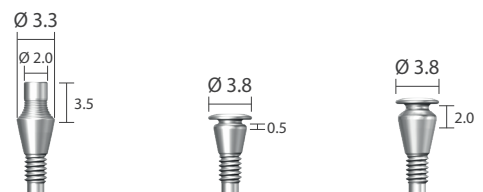

※ Hex driver: Use no more than 10N-cm of torque when screwing a healing abutment to a fixture. If hex is worn, slot on the head of the product can be used to rotate it.

# Healing Abutment

Unit: mm, Scale 1.5 : 1

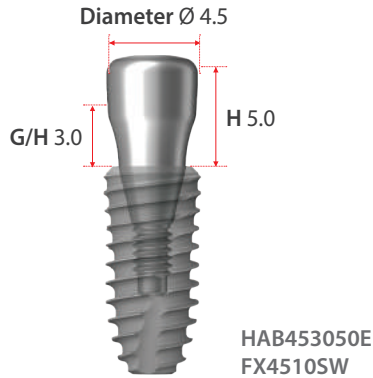

Diameter	G/H	H	Art. No.
Ø 4.0	2.0	2.0	HAB 40 20 20 E
	2.0	3.5	HAB 40 20 35 E
	3.0	5.0	HAB 40 30 50 E
	4.0	7.0	HAB 40 40 70 E
Ø 4.5	2.0	2.0	HAB 45 20 20 E
	2.0	3.5	HAB 45 20 35 E
	3.0	5.0	HAB 45 30 50 E
	4.0	7.0	HAB 45 40 70 E
Ø 5.5	2.0	2.0	HAB 55 20 20 E
	2.0	3.5	HAB 55 20 35 E
	3.0	5.0	HAB 55 30 50 E
	4.0	7.0	HAB 55 40 70 E
Ø 6.5	2.0	2.0	HAB 65 20 20 E
	2.0	3.5	HAB 65 20 35 E
	3.0	5.0	HAB 65 30 50 E
	4.0	7.0	HAB 65 40 70 E

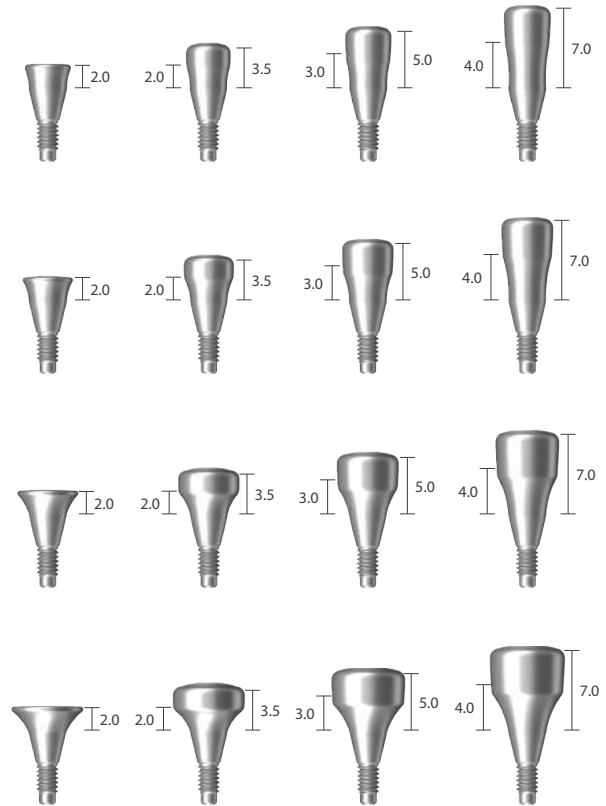

※ Hex driver: Use no more than 10N-cm of torque when screwing a healing abutment to a fixture.  
If hex is worn, slot on the head of the product can be used to rotate it.



# Healing Abutment

Unit: mm, Scale 1.5 : 1

Diameter	G/H	H	Art. No.
Ø 7.5	2.0	3.5	HAB 75 20 35 E
	3.0	5.0	HAB 75 30 50 E

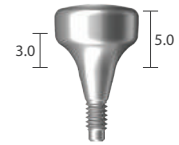
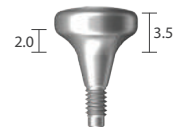

Ø 8.5	2.0	3.5	HAB 85 20 35 E
	3.0	5.0	HAB 85 30 50 E

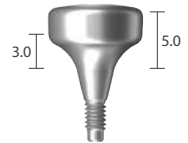
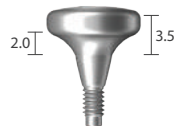

Ø 9.5	2.0	3.5	HAB 95 20 35 E
	3.0	5.0	HAB 95 30 50 E



※ Hex driver: Use no more than 10N-cm of torque when screwing a healing abutment to a fixture.  
If hex is worn, slot on the head of the product can be used to rotate it.

# Scan Abutment

Unit: mm, Scale 1.5 : 1

Diameter	Height	G/H	Type	Art. No.
Ø 4.0	6.0	2.5	Hex	IHAB 40 06 H
	6.0	2.5	Non-hex	IHAB 40 06 N
	8.0	3.0	Hex	IHAB 40 08 H
	8.0	3.0	Non-hex	IHAB 40 08 N
	10.0	3.5	Hex	IHAB 40 10 H
	10.0	3.5	Non-hex	IHAB 40 10 N

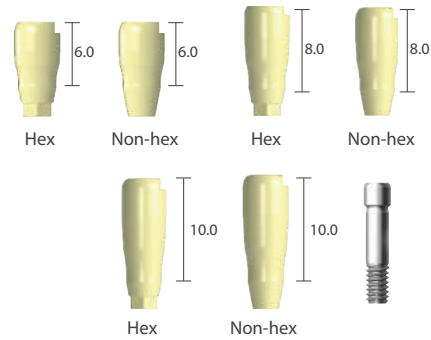

Diameter	Height	G/H	Type	Art. No.
Ø 5.0	6.0	2.5	Hex	IHAB 50 06 H
	6.0	2.5	Non-hex	IHAB 50 06 N
	8.0	3.0	Hex	IHAB 50 08 H
	8.0	3.0	Non-hex	IHAB 50 08 N
	10.0	3.5	Hex	IHAB 50 10 H
	10.0	3.5	Non-hex	IHAB 50 10 N

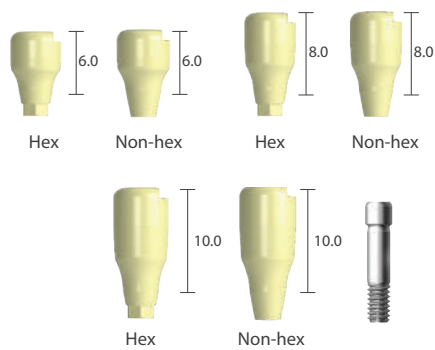

Diameter	Height	G/H	Type	Art. No.
Ø 6.0	6.0	2.5	Hex	IHAB 60 06 H
	6.0	2.5	Non-hex	IHAB 60 06 N
	8.0	3.0	Hex	IHAB 60 08 H
	8.0	3.0	Non-hex	IHAB 60 08 N
	10.0	3.5	Hex	IHAB 60 10 H
	10.0	3.5	Non-hex	IHAB 60 10 N

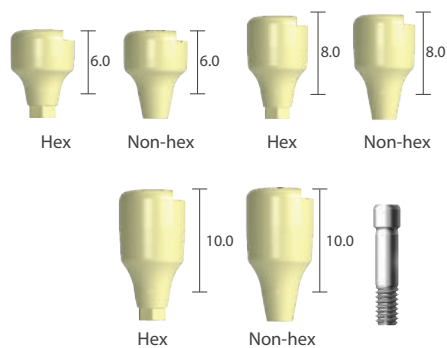

※ Hex driver: Use no more than 10N-cm of torque when screwing a healing abutment to a fixture.  
If hex is worn, slot on the head of the product can be used to rotate it.

# Prosthetic Procedure 1

Impression Technique and Restoration Selection

## Dual / Combi Abutment

### Abutment Level Impression

Closed Tray Technique

Page 13

#### Combi Abutment

Ø 4.5 / Ø 5.5 / Ø 6.5



Page 14, 15

#### Dual Abutment

Hex / Non-hex  
Ø 4.5 / Ø 5.5 / Ø 6.5



Page 16

#### Impression Coping

Transfer (Snap on)  
Ø 4.5 / Ø 5.5 / Ø 6.5



Page 16

#### Analog

Long  
Ø 4.5 / Ø 5.5 / Ø 6.5



Page 16

#### Analog

Short  
Ø 4.5 / Ø 5.5 / Ø 6.5



### Burn-out Cylinder

Page 16

#### Bridge

Rotational  
Ø 4.5 / Ø 5.5 / Ø 6.5



Page 16

#### Single

Non-rotational  
Ø 4.5 / Ø 5.5 / Ø 6.5



### Modification

### Cemented Restoration

# Combi Abutment

Unit: mm, Scale 1 : 1

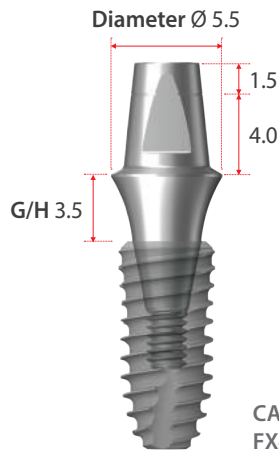

CAB5535E  
FX4510SW

Diameter	G/H	Type	Art. No.	Type	Art. No.
Ø 4.5	1.0	Short	CAB 45 10 SE	Long	CAB 45 10 E
	1.5		CAB 45 15 SE		CAB 45 15 E
	2.5		CAB 45 25 SE		CAB 45 25 E
	3.5		CAB 45 35 SE		CAB 45 35 E
	4.5		CAB 45 45 SE		CAB 45 45 E
	5.5		CAB 45 55 SE		CAB 45 55 E

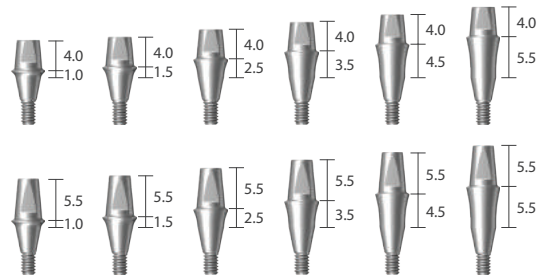

Ø 5.5	1.5	Short	CAB 55 15 SE	Long	CAB 55 15 E
	2.5		CAB 55 25 SE		CAB 55 25 E
	3.5		CAB 55 35 SE		CAB 55 35 E
	4.5		CAB 55 45 SE		CAB 55 45 E
	5.5		CAB 55 55 SE		CAB 55 55 E

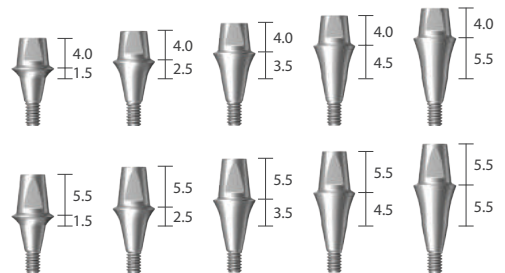

Ø 6.5	1.5	Short	CAB 65 15 SE	Long	CAB 65 15 E
	2.5		CAB 65 25 SE		CAB 65 25 E
	3.5		CAB 65 35 SE		CAB 65 35 E
	4.5		CAB 65 45 SE		CAB 65 45 E
	5.5		CAB 65 55 SE		CAB 65 55 E

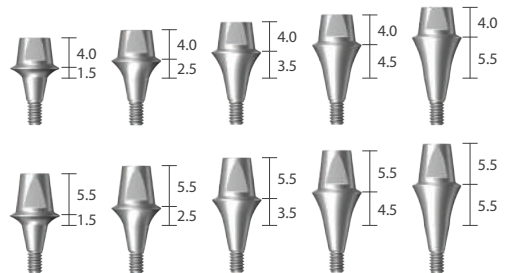

※ Note: It is recommended to keep the torque level at 25~30 N·cm to tighten the combi abutment with fixture.



# Dual Abutment\_Hex

Unit: mm, Scale 1.5 : 1

· Abutment screw is included

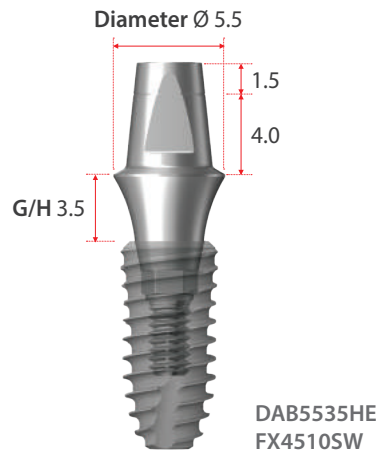

Diameter	G/H	Art. No.
Ø 4.5	1.0	DAB 45 10 HE
	1.5	DAB 45 15 HE
	2.5	DAB 45 25 HE
	3.5	DAB 45 35 HE
	4.5	DAB 45 45 HE
	5.5	DAB 45 55 HE
Ø 5.5	1.5	DAB 55 15 HE
	2.5	DAB 55 25 HE
	3.5	DAB 55 35 HE
	4.5	DAB 55 45 HE
	5.5	DAB 55 55 HE
Ø 6.5	1.5	DAB 65 15 HE
	2.5	DAB 65 25 HE
	3.5	DAB 65 35 HE
	4.5	DAB 65 45 HE
	5.5	DAB 65 55 HE

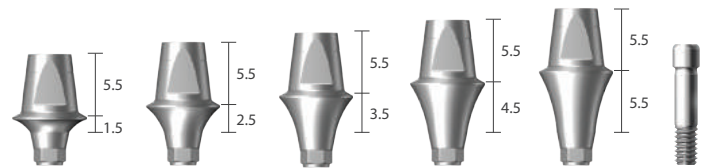
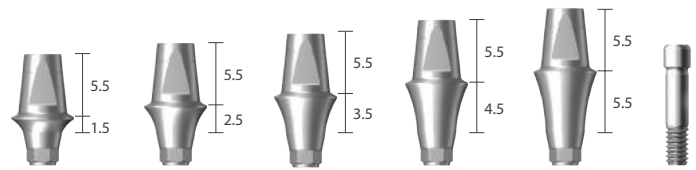
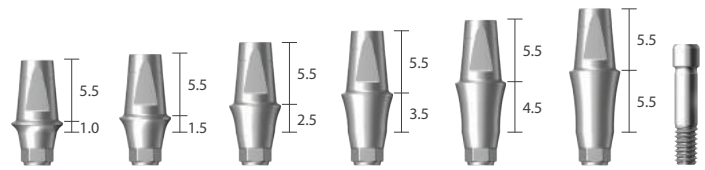

※ Note: It is recommended to keep the torque level at 25~30 N·cm to tighten the dual abutment with fixture.

# Dual Abutment\_Non-hex

Unit: mm, Scale 1.5 : 1

· Abutment screw is included

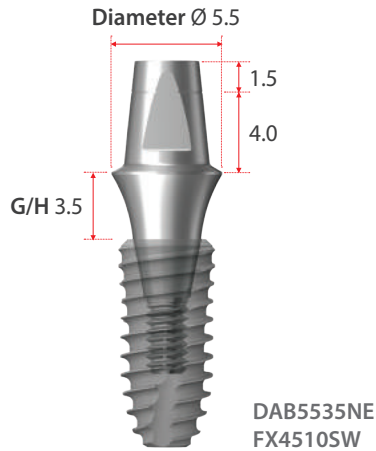

Diameter	G/H	Art. No.
$\varnothing$ 4.5	1.0	DAB 45 10 NE
	1.5	DAB 45 15 NE
	2.5	DAB 45 25 NE
	3.5	DAB 45 35 NE
	4.5	DAB 45 45 NE
	5.5	DAB 45 55 NE
$\varnothing$ 5.5	1.5	DAB 55 15 NE
	2.5	DAB 55 25 NE
	3.5	DAB 55 35 NE
	4.5	DAB 55 45 NE
	5.5	DAB 55 55 NE
$\varnothing$ 6.5	1.5	DAB 65 15 NE
	2.5	DAB 65 25 NE
	3.5	DAB 65 35 NE
	4.5	DAB 65 45 NE
	5.5	DAB 65 55 NE

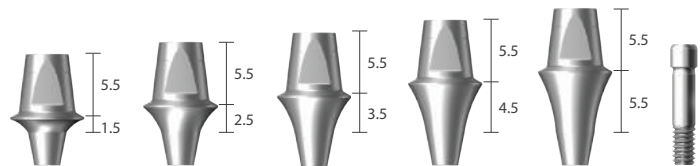
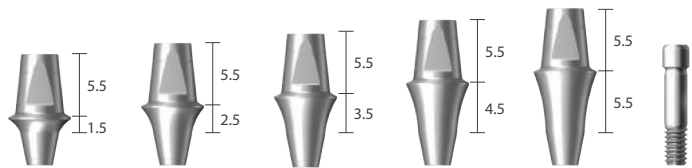
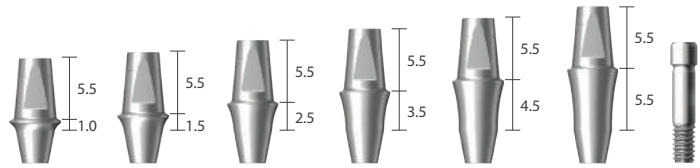

※ Note: It is recommended to keep the torque level at 25~30 N·cm to tighten the dual abutment with fixture.

# Abutment Level Impression Components

Unit: mm, Scale 1 : 1

## Comfort Cap | Snap on

Type	Diameter	Art. No.
Short	Ø 4.5	CCC 45 CS
	Ø 5.5	CCC 55 CS
	Ø 6.5	CCC 65 CS
Long	Ø 4.5	CCC 45 C
	Ø 5.5	CCC 55 C
	Ø 6.5	CCC 65 C

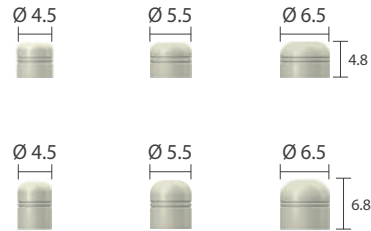

## Impression Coping

Diameter	Art. No.
Ø 4.5	CIC 45 L
Ø 5.5	CIC 55 L
Ø 6.5	CIC 65 L



## Lab Analog

Type	Diameter	Art. No.
Short	Ø 4.5	CAN 45 SL
	Ø 5.5	CAN 55 SL
	Ø 6.5	CAN 65 SL
Long	Ø 4.5	CAN 45 LL
	Ø 5.5	CAN 55 LL
	Ø 6.5	CAN 65 LL

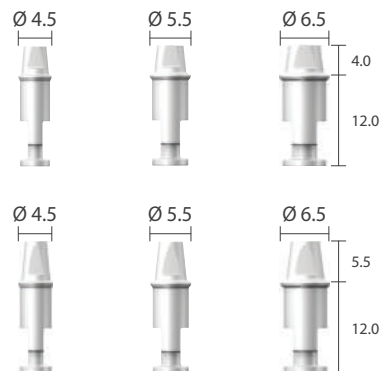

## Burn-out Cylinder

Type	Diameter	Art. No.
Single	Ø 4.5	CBC 45 SL
	Ø 5.5	CBC 55 SL
	Ø 6.5	CBC 65 SL
Bridge	Ø 4.5	CBC 45 BL
	Ø 5.5	CBC 55 BL
	Ø 6.5	CBC 65 BL



# Restorative Kit



## Combi & Dual Abutment

Art. No	Lab. Components				
	Comfort Cap	Impression Coping	Analog	Burn-out Cylinder	
XSDAB 45 S XSDAB 45	CCC 45 CS CCC 45 C	CIC 45 L	CAN 45 SL CAN 45 LL	CBC 45 SL	CBC 45 BL
XSDAB 55 S XSDAB 55	CCC 55 CS CCC 55 C	CIC 55 L	CAN 55 SL CAN 55 LL	CBC 55 SL	CBC 55 BL
XSDAB 65 S XSDAB 65	CCC 65 CS CCC 65 C	CIC 65 L	CAN 65 SL CAN 65 LL	CBC 65 SL	CBC 65 BL



# Prosthetic Procedure 2

Impression Technique and Restoration Selection

Dual / Custom / Milling / Angled / Direct-Casting / Metal-Casting /  
Ti-Temporary / Plastic Temporary Abutment

## Fixture Level Impression

Page 19

### Impression Coping Pick-up

Open tray technique (Complicated case)  
Ø 4.0 / Ø 4.5 / Ø 5.5 / Ø 6.5



Page 20

### Impression Coping Transfer

Closed tray technique (Simple case)  
Ø 4.0 / Ø 4.5 / Ø 5.5 / Ø 6.5

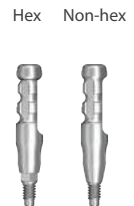

### Analog

Ø 4.5



Page 14, 15

### Dual Abutment

Hex / Non-hex  
Ø 4.5 / Ø 5.5 / Ø 6.5



Page 21

### Custom Abutment

Hex / Non-hex  
Ø 4.5 / Ø 5.5



Page 26

### Direct-Casting Abutment

Hex / Non-hex  
Ø 4.5



Page 26

### Metal-Casting Abutment

Hex / Non-hex  
Ø 4.5



Page 22, 23

### Milling Abutment

Hex / Non-hex  
Ø 4.0 / Ø 4.5 /  
Ø 5.5 / Ø 6.5 / Ø 7.5



Page 24, 25

### Angled Abutment

Hex / Non-hex  
15° / 25°  
Ø 4.5 / Ø 5.5



Page 27

### Ti-Temporary Abutment

Hex / Non-hex  
Ø 4.5



Page 27

### Plastic Temporary Abutment

Hex / Non-hex  
Ø 4.5 / Ø 5.5 / Ø 6.5



Modification

Cemented Restoration

Modification

Screw-Retained Restoration

# Fixture Level Impression Components

Unit: mm, Scale 1 : 1

· Impression coping screw is included with Impression coping.

## Impression Coping Pick-up

Diameter	Size	Type	Art. No.
Ø 4.0	Short	Hex	DPU 40 11 HE
	Short	Non-hex	DPU 40 11 NE
	Long	Hex	DPU 40 15 HE
	Long	Non-hex	DPU 40 15 NE

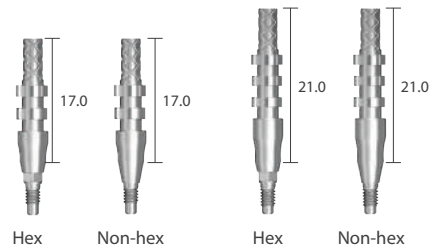

Ø 4.5	Short	Hex	DPU 45 11 HE
	Short	Non-hex	DPU 45 11 NE
	Long	Hex	DPU 45 15 HE
	Long	Non-hex	DPU 45 15 NE

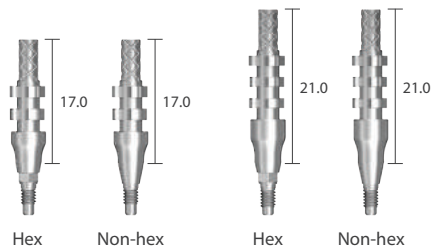

Ø 5.5	Short	Hex	DPU 55 11 HE
	Short	Non-hex	DPU 55 11 NE
	Long	Hex	DPU 55 15 HE
	Long	Non-hex	DPU 55 15 NE

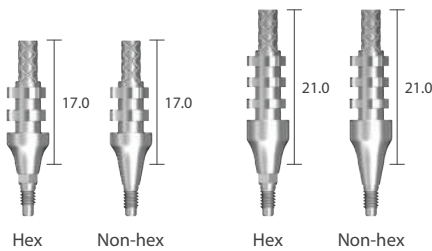

Ø 6.5	Short	Hex	DPU 65 11 HE
	Short	Non-hex	DPU 65 11 NE
	Long	Hex	DPU 65 15 HE
	Long	Non-hex	DPU 65 15 NE

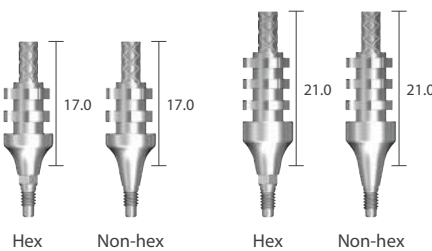

## Impression Coping Transfer Screw

Size	L	Art. No.
Short	23.0	DPS 11 E
Long	27.0	DPS 15 E

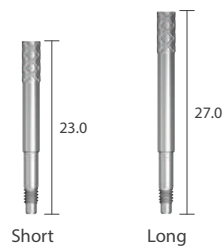

## Analog

Diameter	L	Art. No.
Ø 4.5	12.0	DANSE

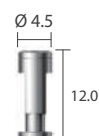

# Fixture Level Impression Components

Unit: mm, Scale 1 : 1

· Impression coping screw is included with Impression coping.

## Impression Coping Transfer

Diameter	Size	Type	Art. No.
Ø 4.0	Short	Hex	DTF 40 11 HE
	Short	Non-hex	DTF 40 11 NE
	Long	Hex	DTF 40 15 HE
	Long	Non-hex	DTF 40 15 NE

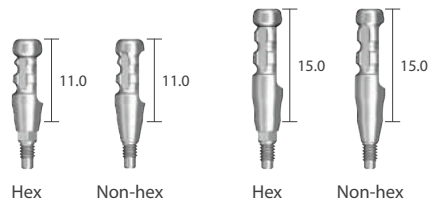

Ø 4.5	Short	Hex	DTF 45 11 HE
	Short	Non-hex	DTF 45 11 NE
	Long	Hex	DTF 45 15 HE
	Long	Non-hex	DTF 45 15 NE

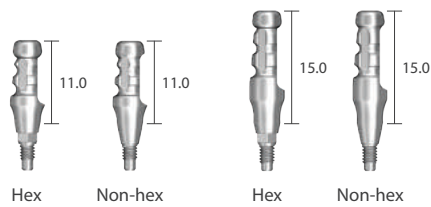

Ø 5.5	Short	Hex	DTF 55 11 HE
	Short	Non-hex	DTF 55 11 NE
	Long	Hex	DTF 55 15 HE
	Long	Non-hex	DTF 55 15 NE

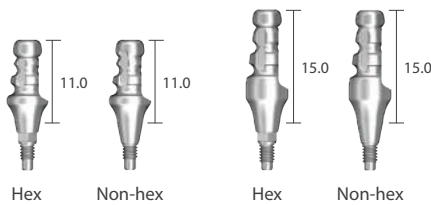

Ø 6.5	Short	Hex	DTF 65 11 HE
	Short	Non-hex	DTF 65 11 NE
	Long	Hex	DTF 65 15 HE
	Long	Non-hex	DTF 65 15 NE

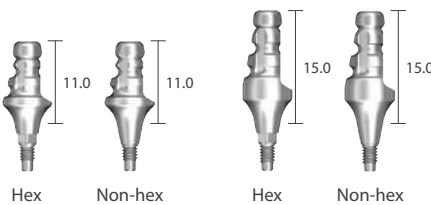

## Impression Coping Transfer Screw

Size	L	Art. No.
Short	17.0	DTS 11 E
Long	21.0	DTS 15 E

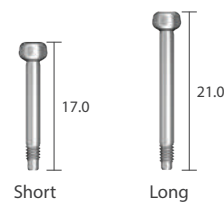

## Analog

Diameter	L	Art. No.
Ø 4.5	12.0	DANSE

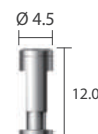

# Custom Abutment

Unit: mm, Scale 1.5 : 1

· Abutment screw is included.

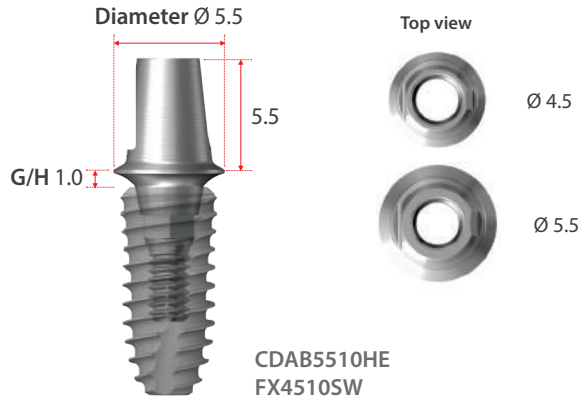

Diameter	G/H	Type	Art. No.
Ø 4.5	0.5	Hex	CDAB 45 05 HE
	0.5	Non-hex	CDAB 45 05 NE
	1.5	Hex	CDAB 45 15 HE
	1.5	Non-hex	CDAB 45 15 NE
Ø 5.5	1.0	Hex	CDAB 55 10 HE
	1.0	Non-hex	CDAB 55 10 NE
	2.0	Hex	CDAB 55 20 HE
	2.0	Non-hex	CDAB 55 20 NE

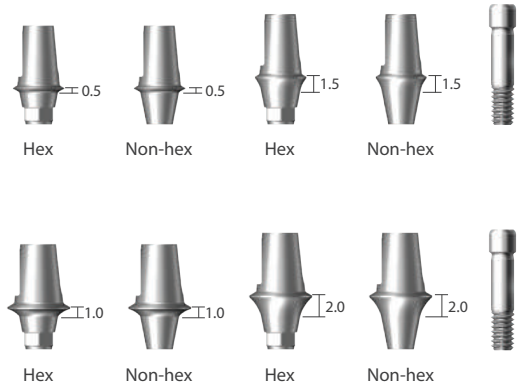

※ Note: It is recommended to keep the torque level at 25~30 N·cm to tighten the custom abutment with fixture.



# Milling Abutment

Unit: mm, Scale 1.5 : 1

· Abutment screw is included.

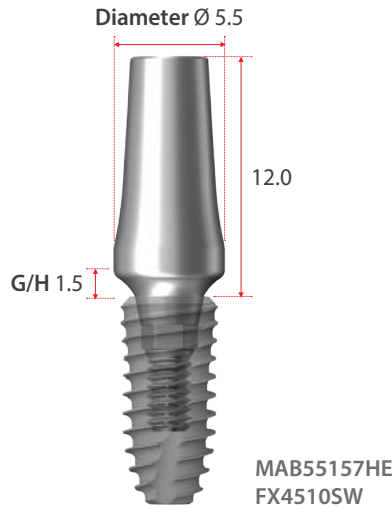

Diameter	G/H	Type	Art. No.
Ø 4.0	1.0	Hex	MAB 40 105 HE
	1.0	Non-hex	MAB 40 105 NE

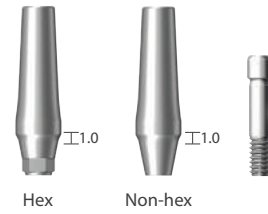

Diameter	G/H	Type	Art. No.
Ø 4.5	1.5	Hex	MAB 45 156 HE
	1.5	Non-hex	MAB 45 156 NE

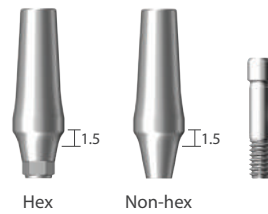

Diameter	G/H	Type	Art. No.
Ø 5.5	1.5	Hex	MAB 55 157 HE
	1.5	Non-hex	MAB 55 157 NE
	2.5	Hex	MAB 55 257 HE
	2.5	Non-hex	MAB 55 257 NE

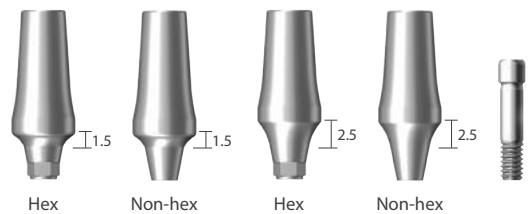

※ Note: It is recommended to keep the torque level at 25~30 N·cm to tighten the milling abutment with fixture.

# Milling Abutment

Unit: mm, Scale 1.5 : 1

· Abutment screw is included.

Diameter	G/H	Type	Art. No.
Ø 6.5	1.5	Hex	MAB 65 158 HE
	1.5	Non-hex	MAB 65 158 NE
	2.5	Hex	MAB 65 258 HE
	2.5	Non-hex	MAB 65 258 NE
	3.5	Hex	MAB 65 358 HE
	3.5	Non-hex	MAB 65 358 NE

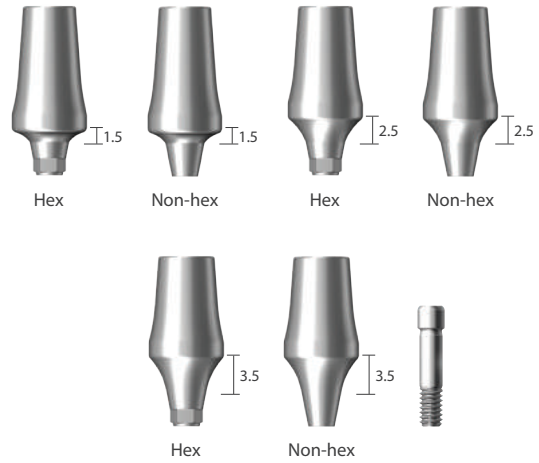

Diameter	G/H	Type	Art. No.
Ø 7.5	2.5	Hex	MAB 75 259 HE
	2.5	Non-hex	MAB 75 259 NE
	3.5	Hex	MAB 75 359 HE
	3.5	Non-hex	MAB 75 359 NE



※ Note: It is recommended to keep the torque level at 25~30 N·cm to tighten the milling abutment with fixture.

# Angled Abutment\_15°

Unit: mm, Scale 1.5 : 1

· Abutment screw is included.

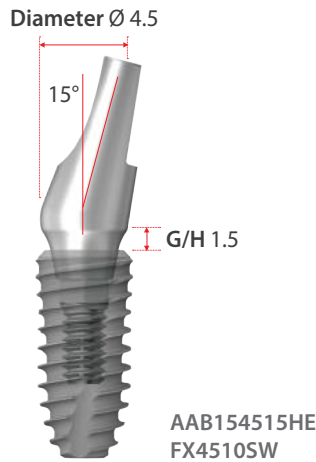

Diameter	G/H	Type	Art. No.
$\varnothing$ 4.5	1.5	Hex	AAB 15 45 15 HE
	1.5	Non-hex	AAB 15 45 15 NE
	2.5	Hex	AAB 15 45 25 HE
	2.5	Non-hex	AAB 15 45 25 NE
	3.5	Hex	AAB 15 45 35 HE
	3.5	Non-hex	AAB 15 45 35 NE

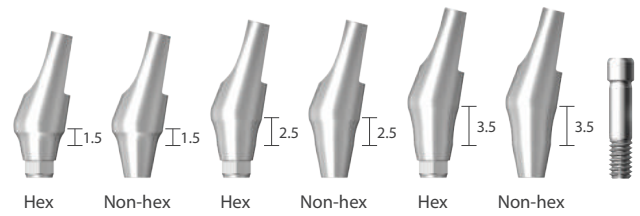

Diameter	G/H	Type	Art. No.
$\varnothing$ 5.5	1.5	Hex	AAB 15 55 15 HE
	1.5	Non-hex	AAB 15 55 15 NE
	2.5	Hex	AAB 15 55 25 HE
	2.5	Non-hex	AAB 15 55 25 NE
	3.5	Hex	AAB 15 55 35 HE
	3.5	Non-hex	AAB 15 55 35 NE



※ Note: It is recommended to keep the torque level at 25~30 N·cm to tighten the angled abutment with fixture.

# Angled Abutment\_25°

Unit: mm, Scale 1.5 : 1

· Abutment screw is included.

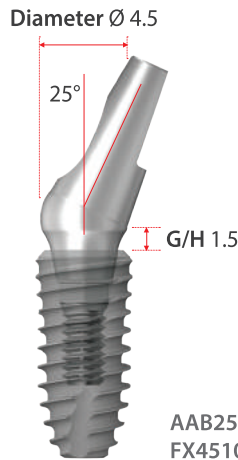

Diameter	G/H	Type	Art. No.
$\varnothing$ 4.5	1.5	Hex	AAB 25 45 15 HE
	1.5	Non-hex	AAB 25 45 15 NE
	2.5	Hex	AAB 25 45 25 HE
	2.5	Non-hex	AAB 25 45 25 NE
	3.5	Hex	AAB 25 45 35 HE
	3.5	Non-hex	AAB 25 45 35 NE



Diameter	G/H	Type	Art. No.
$\varnothing$ 5.5	1.5	Hex	AAB 25 55 15 HE
	1.5	Non-hex	AAB 25 55 15 NE
	2.5	Hex	AAB 25 55 25 HE
	2.5	Non-hex	AAB 25 55 25 NE
	3.5	Hex	AAB 25 55 35 HE
	3.5	Non-hex	AAB 25 55 35 NE



※ Note: It is recommended to keep the torque level at 25~30 N·cm to tighten the angled abutment with fixture.

# Direct-Casting Abutment

Unit: mm, Scale 1.5 : 1

- Abutment screw is included.

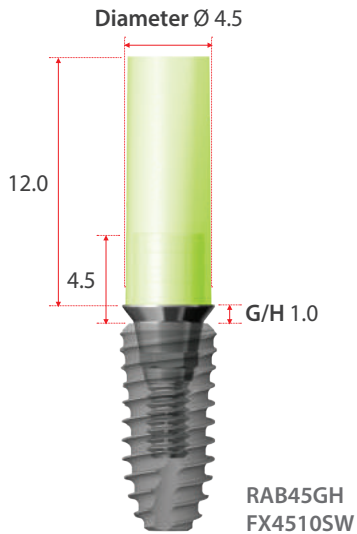

Gold

Diameter	G/H	Type	Art. No.
$\varnothing$ 4.5	1.0	Hex	RAB 45 GH
		Non-hex	RAB 45 GN

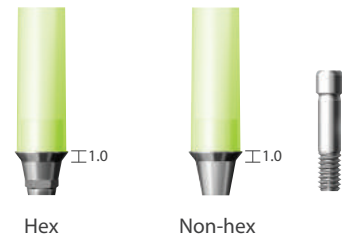

# Metal-Casting Abutment

Unit: mm, Scale 1.5 : 1

- Abutment screw is included.

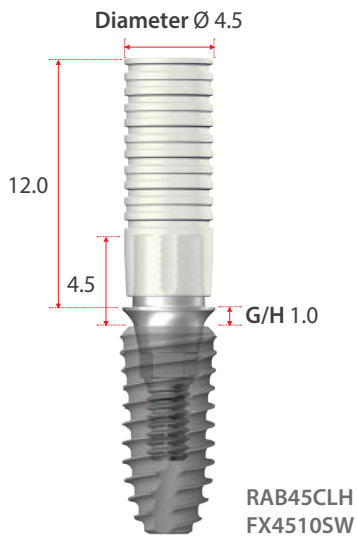

Co-Cr

Diameter	G/H	Type	Art. No.
$\varnothing$ 4.5	1.0	Hex	RAB 45 CLH
		Non-hex	RAB 45 CLN



※ Note: It is recommended to keep the torque level at 25~30 N·cm to tighten the direct casting/metal casting abutment with fixture.



# Ti-Temporary Abutment

Unit: mm, Scale 1.5 : 1

• Abutment screw is included.

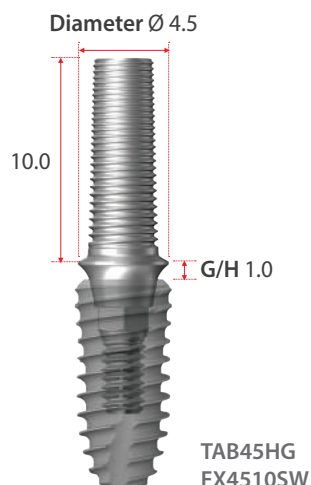

Diameter	G/H	Type	Art. No.
$\varnothing$ 4.5	1.0	Hex	TAB 45 HG
		Non-hex	TAB 45 NG

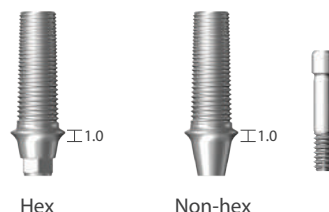

# Plastic Temporary Abutment

Unit: mm, Scale 1.5 : 1

• Abutment screw is included.

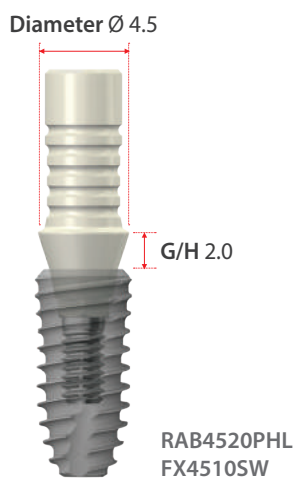

Diameter	G/H	Type	Art. No.
$\varnothing$ 4.5	2.0	Hex	RAB 45 20 PHL
		Non-hex	RAB 45 20 PNL
$\varnothing$ 5.5	2.0	Hex	RAB 55 20 PHL
		Non-hex	RAB 55 20 PNL
$\varnothing$ 6.5	2.0	Hex	RAB 65 20 PHL
		Non-hex	RAB 65 20 PNL

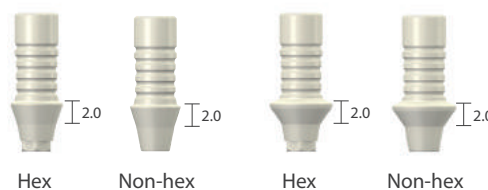

※ Note: It is recommended to keep the torque level at 25~30 N-cm to tighten the temporary abutment with fixture.

# Prosthetic Procedure 3

## Impression Technique and Restoration Selection

### Screw Abutment

#### Abutment Level Impression

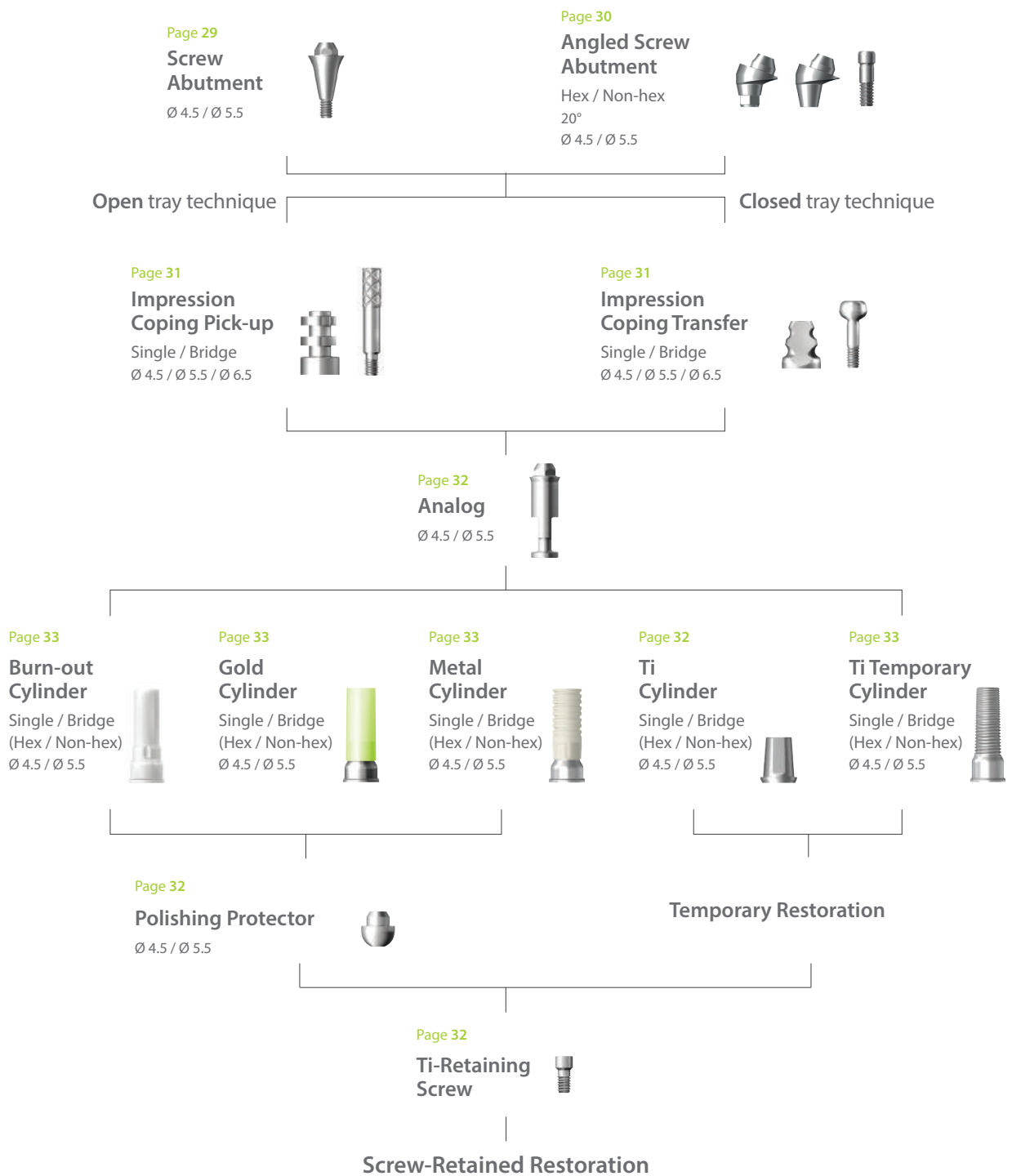

# Screw Abutment

Unit: mm, Scale 1.5 : 1

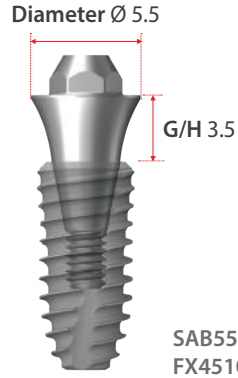

Diameter	G/H	Art. No.
Ø 4.5	1.0	SAB 45 10 E
	1.5	SAB 45 15 E
	2.5	SAB 45 25 E
	3.5	SAB 45 35 E
	4.5	SAB 45 45 E
	5.5	SAB 45 55 E

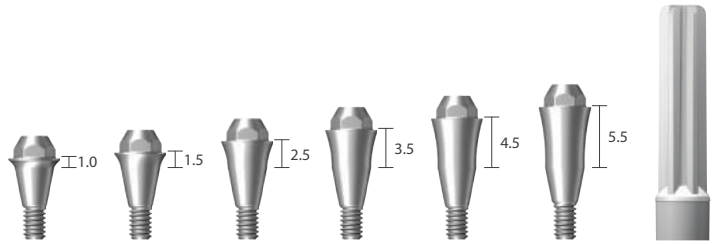

Diameter	G/H	Art. No.
Ø 5.5	1.5	SAB 55 15 E
	2.5	SAB 55 25 E
	3.5	SAB 55 35 E
	4.5	SAB 55 45 E
	5.5	SAB 55 55 E

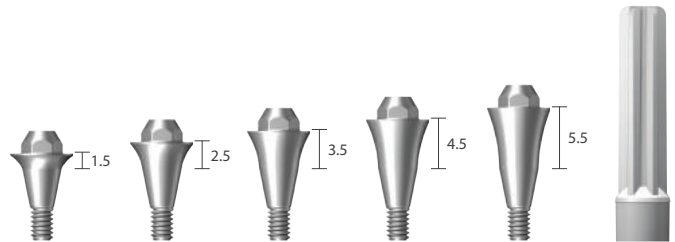

※ Note: It is recommended to keep the torque level at 25~30 N·cm to tighten the screw abutment with fixture.

# Angled Screw Abutment

Unit: mm, Scale 1.5 : 1

· Abutment screw is included.

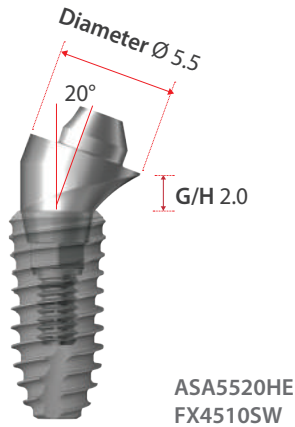

Diameter	G/H	Type	Art. No.
Ø 4.5	1.0	Hex	ASA 45 10 HE
	1.0	Non-hex	ASA 45 10 NE
	2.0	Hex	ASA 45 20 HE
	2.0	Non-hex	ASA 45 20 NE
	3.0	Hex	ASA 45 30 HE
	3.0	Non-hex	ASA 45 30 NE

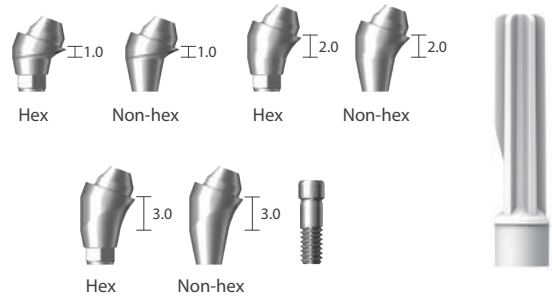

Diameter	G/H	Type	Art. No.
Ø 5.5	1.0	Hex	ASA 55 10 HE
	1.0	Non-hex	ASA 55 10 NE
	2.0	Hex	ASA 55 20 HE
	2.0	Non-hex	ASA 55 20 NE
	3.0	Hex	ASA 55 30 HE
	3.0	Non-hex	ASA 55 30 NE

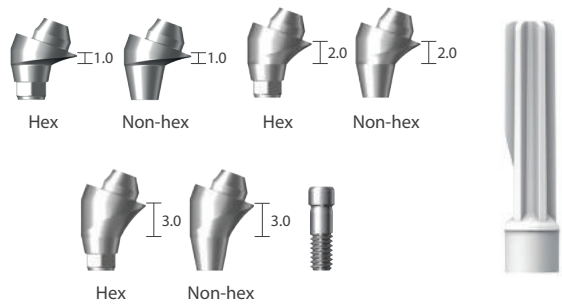

## Angled Screw Abutment Screw

Diameter	L	Art. No.
Ø 2.3	7.3	ASASC 20 23

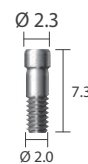

※ Note: It is recommended to keep the torque level at 25~30 N·cm to tighten the angled screw abutment with fixture.

# Screw Abutment Impression Components

Unit: mm, Scale 1.5 : 1

## Impression Coping Pick-up

Diameter	Type		Art. No.
Ø 4.5	Single	Hex	SPU 45 SL
	Bridge	Non-hex	SPU 45 BL
Ø 5.5	Single	Hex	SPU 55 SL
	Bridge	Non-hex	SPU 55 BL

Ø 4.5



Single (Hex)

Ø 4.5



Bridge (Non-hex)

Ø 5.5



Single (Hex)

Ø 5.5



Bridge (Non-hex)

## Impression Coping Transfer

Diameter	Type		Art. No.
Ø 4.5	Single	Hex	STF 45 SL
	Bridge	Non-hex	STF 45 BL
Ø 5.5	Single	Hex	STF 55 SL
	Bridge	Non-hex	STF 55 BL

Ø 4.5



Single (Hex)

Ø 4.5



Bridge (Non-hex)

Ø 5.5



Single (Hex)

Ø 5.5



Bridge (Non-hex)

## Impression Coping Screw

Type	L	Art. No.
Pick-up	15.0	SPS 09
Transfer	9.0	STS 09



15.0



9.0



# Screw Abutment Impression Components

Unit: mm, Scale 1.5 : 1

## Comfort Cap

Diameter	L	Art. No.
Ø 4.5	5.0	SCC 45 L
Ø 5.5		SCC 55 L



## Analog

Diameter	L	Art. No.
Ø 4.5	12.0	SAN 45 L
Ø 5.5		SAN 55 L

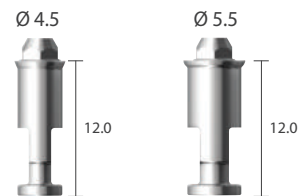

## Polishing Protector

Diameter	L	Art. No.
Ø 4.5	4.71	SPP 45 L
Ø 5.5		SPP 55 L



## Ti-Retaining Screw

Diameter	L	Art. No.
Ø 2.3	5.0	SRS 18 T

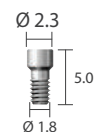

## Ti-Cylinder

Diameter	Type		Art. No.
Ø 4.5	Single Bridge	Hex	STA 45 S
		Non-hex	STA 45 B
Ø 5.5	Single Bridge	Hex	STA 55 S
		Non-hex	STA 55 B

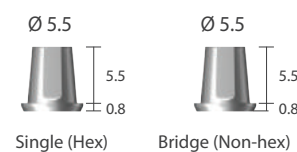
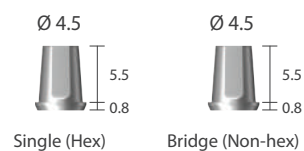

# Screw Abutment Impression Components

Unit: mm, Scale 1.5 : 1

## Ti-Temporary Cylinder

Diameter	Type		Art. No.
Ø 4.5	Single Bridge	Hex	STC 45 SG
		Non-hex	STC 45 BG
Ø 5.5	Single Bridge	Hex	STC 55 SG
		Non-hex	STC 55 BG

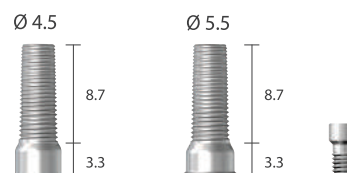

## Gold Cylinder

Diameter	Type		Art. No.
Ø 4.5	Single Bridge	Hex	SGC 45 SL
		Non-hex	SGC 45 BL
Ø 5.5	Single Bridge	Hex	SGC 55 SL
		Non-hex	SGC 55 BL

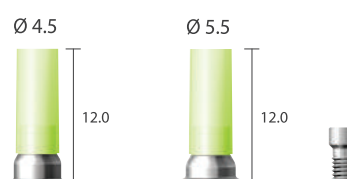

## Metal Cylinder | Co-Cr

Diameter	Type		Art. No.
Ø 4.5	Single Bridge	Hex	SGC 45 CSL
		Non-hex	SGC 45 CBL
Ø 5.5	Single Bridge	Hex	SGC 55 CSL
		Non-hex	SGC 55 CBL

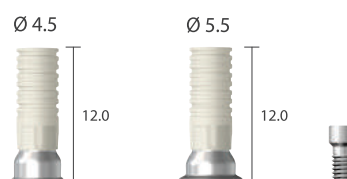

## Burn-out Cylinder

Diameter	Type		Art. No.
Ø 4.5	Single Bridge	Hex	SBC 45 SL
		Non-hex	SBC 45 BL
Ø 5.5	Single Bridge	Hex	SBC 55 SL
		Non-hex	SBC 55 BL

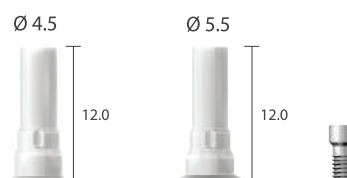

# Prosthetic Procedure 4

Impression Technique and Restoration Type

## Overdenture Procedure

### Positioner / Mini Ball / Magnetic Attachment

Page 35

**Positioner Abutment**

Ø 3.5



Page 37

**Mini Ball Abutment**

Ø 3.5



Page 38, 39

**Magnetic Implant Keeper**

Dome type / Flat type  
Ø 4.5 / Ø 5.5



#### Abutment Level Impression

Page 35

**Positioner Impression Coping**

Ø 4.5



Page 37

**Mini Ball Impression Coping**

Ø 3.5



Page 35

**Positioner Analog**

Ø 3.5



Page 37

**Mini Ball Analog**

Ø 3.5



Page 36

**Block Out Spacer**

Ø 6.5



Page 37

**Socket Spacer**

Ø 4.05 / Ø 4.85



Page 36

**Positioner Socket**

Metal / Plastic

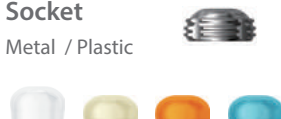

Page 37

**Mini Ball Female Socket / O-ring**

Ø 4.05 / Ø 4.85



Page 38, 39

**Magnetic Assay**

Dome type / Flat type  
Ø 4.5 / Ø 5.5



**Positioner Attachment for Overdenture**

**Mini Ball and Socket Attachment for Overdenture**

**Magnetic Attachment for Overdenture**

# Positioner

Unit: mm, Scale 1.5 : 1

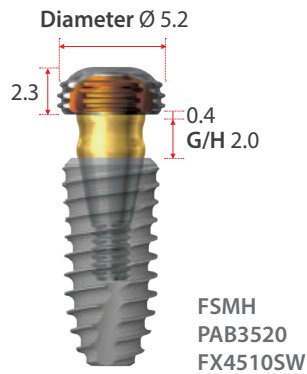

## Positioner Abutment

Diameter	G/H	Art. No.
Ø 3.5	1.0	PAB 35 10
	2.0	PAB 35 20
	3.0	PAB 35 30
	4.0	PAB 35 40
	5.0	PAB 35 50
	6.0	PAB 35 60
	7.0	PAB 35 70

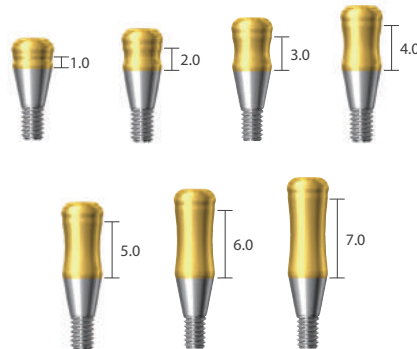

## Positioner Impression Coping

Diameter	L	Art. No.
Ø 4.5	4.5	PIC



## Positioner Analog

Diameter	L	Art. No.
Ø 3.5	12.4	PAN



※ Note: It is recommended to keep the torque level at 25~30 N·cm to tighten the positioner abutment with fixture.

# Positioner

Unit: mm, Scale 1.5 : 1

## Positioner Socket Set

Type	Art. No.
Tilting type $\pm 10^\circ$	FSMHS
Non Tilting type $\pm 5^\circ$	FSMHSN



## Positioner Metal Socket

Diameter	H	Art. No.
$\varnothing 5.2$	2.3	FSMH

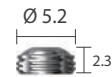

## Positioner Abutment

Type	Application	Art. No.
Tilting type $\pm 10^\circ$	Blue 1,000gf	MSHP
	Orange 500gf	MSMP
	Ivory 300gf	MSLP
	White 100gf	MSOP
Non tilting type $\pm 5^\circ$	Blue 1000gf	MSHPN
	Orange 500gf	MSMPN
	Ivory 300gf	MSLPN
	White 100gf	MSOPN

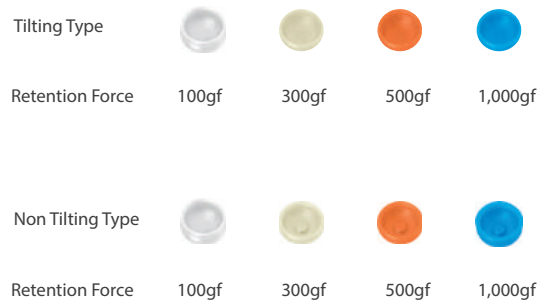

## Positioner Block Out Spacer

Diameter	H	Art. No.
$\varnothing 6.5$	0.5	FSMH



## Positioner Core Tool

XPCT
------





# Mini Ball Attachment

Unit: mm, Scale 1.5 : 1

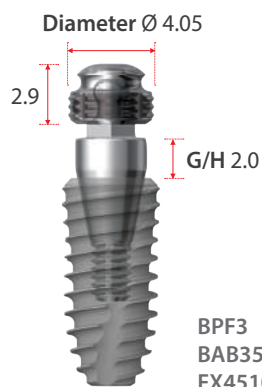

BPF3  
BAB352018  
FX4510SW

## Mini Ball Abutment

Diameter	G/H	Art. No.
Ø 3.3	0	BAB 35 00 18
Ø 3.5	1.0	BAB 35 10 18
Ø 3.5	2.0	BAB 35 20 18
Ø 3.5	3.0	BAB 35 30 18
Ø 3.5	4.0	BAB 35 40 18
Ø 3.5	5.0	BAB 35 50 18

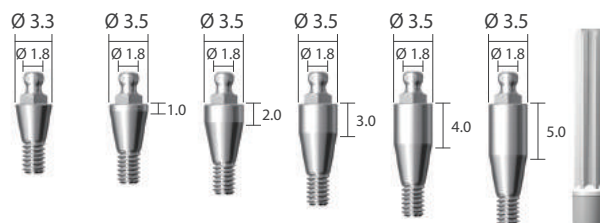

## Mini Ball Impression Coping

Diameter	L	Art. No.
Ø 4.0	5.0	GICA

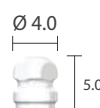

## Mini Ball Analog

Diameter	Art. No.
Ø 3.5	BANL



## Socket Spacer

Diameter	Art. No.
Ø 4.05	GBIC 3 L
Ø 4.85	GBIC 2 L



## Female Socket

Diameter	Retention Force	Art. No.
Ø 4.05	300~500gf	BPF 3
Ø 4.85	500~700gf	BPF 2



※ Note: It is recommended to keep the torque level at 25~30 N·cm to tighten the mini ball abutment with fixture.

# Magnetic Attachment\_Dome Type

Unit: mm, Scale 1.5 : 1

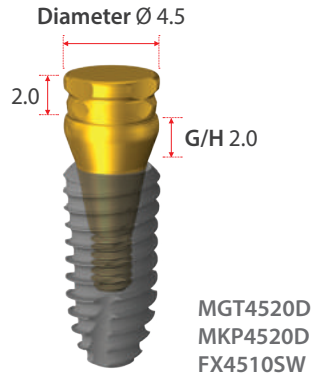

## Magnetic Assay

Application	Diameter	H	Art. No.
MKP45D	$\varnothing$ 4.5	2.0	MGT 45 20 D
MKP55D	$\varnothing$ 5.5	2.0	MGT 55 20 D

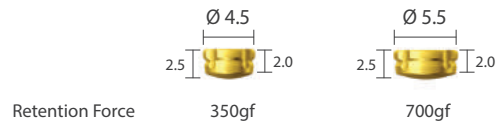

## Implant Keeper Diameter

Diameter	G/H	Art. No.
$\varnothing$ 4.5	1.0	MKP 45 10 D
	2.0	MKP 45 20 D
	3.0	MKP 45 30 D
	4.0	MKP 45 40 D
	5.0	MKP 45 50 D
	6.0	MKP 45 60 D
$\varnothing$ 5.5	1.0	MKP 55 10 D
	2.0	MKP 55 20 D
	3.0	MKP 55 30 D
	4.0	MKP 55 40 D
	5.0	MKP 55 50 D
	6.0	MKP 55 60 D

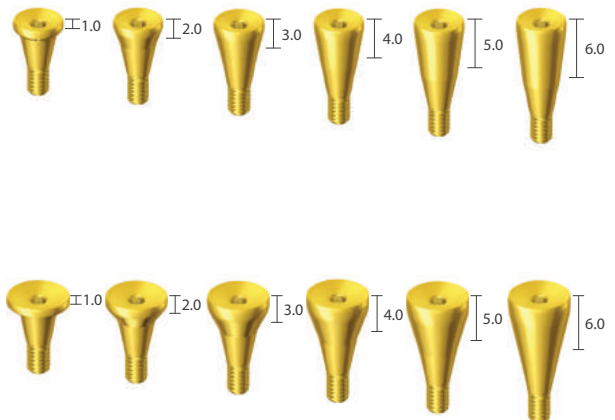

※ Note: It is recommended to keep the torque level at 25~30 N-cm to tighten the magnetic abutment with fixture.

# Magnetic Attachment\_Flat Type

Unit: mm, Scale 1.5 : 1

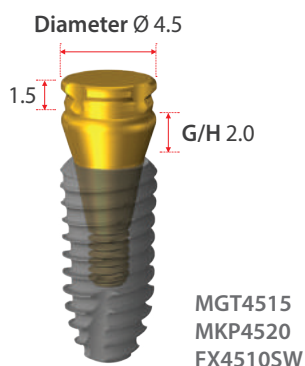

## Magnetic Assay

Application	Diameter	H	Art. No.
MKP 45	Ø 4.5	1.5	MGT 45 15
	Ø 4.5	2.0	MGT 45 20
MKP 55	Ø 5.5	1.5	MGT 55 15
	Ø 5.5	2.0	MGT 55 20

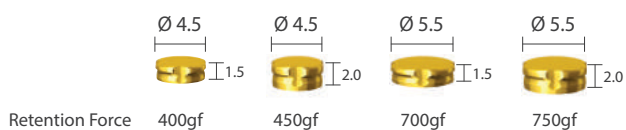

## Implant Keeper Diameter

Diameter	G/H	Art. No.
Ø 4.5	1.0	MKP 45 10
	2.0	MKP 45 20
	3.0	MKP 45 30
	4.0	MKP 45 40
	5.0	MKP 45 50
	6.0	MKP 45 60
Ø 5.5	1.0	MKP 55 10
	2.0	MKP 55 20
	3.0	MKP 55 30
	4.0	MKP 55 40
	5.0	MKP 55 50
	6.0	MKP 55 60

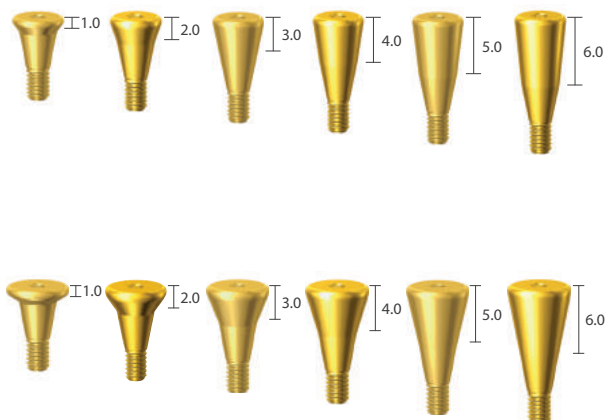

※ Note: It is recommended to keep the torque level at 25~30 N·cm to tighten the magnetic abutment with fixture.

# Surgical Kit\_Full

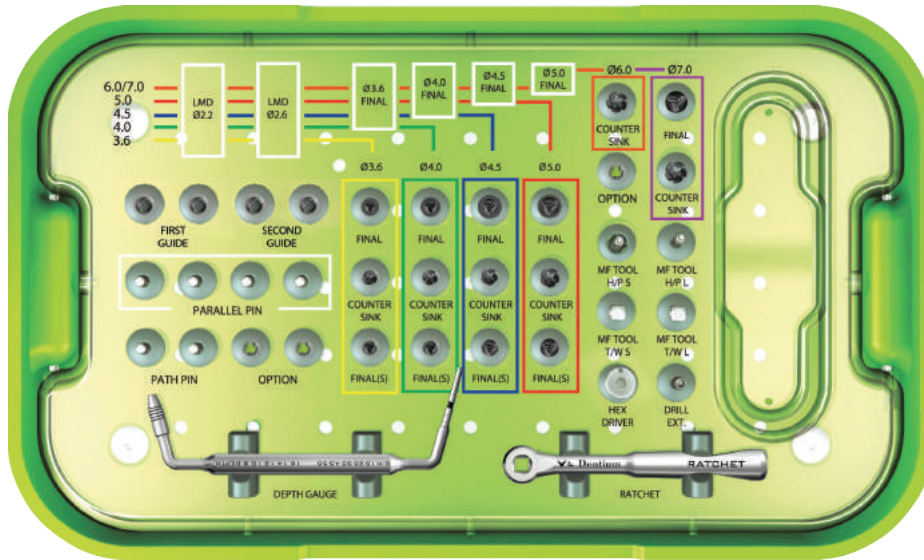

## SuperLine Surgical Full Kit

UXNF

### Kit Includes

#### First Guide Drill



XLD2229 XLD2235 (Stopper) XLD2629 XLD2635 (Stopper)

#### Second Guide Drill

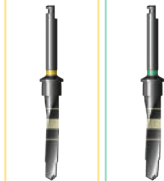

XFD3435 XFD3835

#### Final Drill

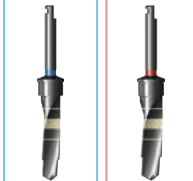

XFD4335 XFD4835

#### Hand-piece Adapter



XFD5831 XFA27H XFA32H

#### Parallel Pin



XPP162220 T

#### Countersink

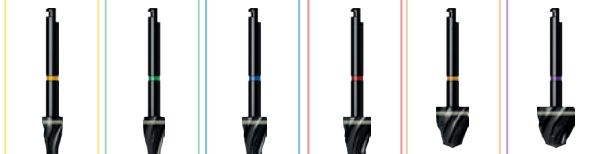

XCS3629SW XCS4029SW XCS4529SW XCS5029SW XCS6029SW XCS7029SW

#### Ratchet Adapter



XFA26W XFA32W

#### MF Path Pin



XMFPA2

#### Final Drill(s)

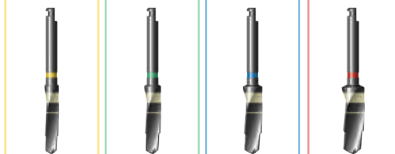

XFD3429 XFD3829 XFD4329 XFD4829

#### Hex Driver Drill Extension



XHD26T XDE

#### Depth Gauge



XDGL

#### Ratchet



XRCA1

# Surgical Kit\_Standard



## SuperLine Surgical Standard Kit

UXNS

### Kit Includes

#### First Guide Drill



XLD2231



XFD3431



XFD3831



XFD4331



XFD4831



XFD5831

#### Final Drill

#### Second Guide Drill



XLD2631



XCS3629SW



XCS4029SW



XCS4529SW



XCS5029SW



XCS7029SW

#### Parallel Pin



XPP162220T



XPP162226T

#### MF Path Pin



XMFPA2



XMFPA2

#### Hex Driver (Hand-piece)



XHD25H



XHD26T

#### Hex Driver



XCS6029SW



XDE

#### Hand-piece Adapter



XFA30H



XFA26W

#### Drill Extension



XDE

#### Ratchet Adapter



XFA26W

#### Ratchet



XRC A1



# Surgical Kit\_Short Implant

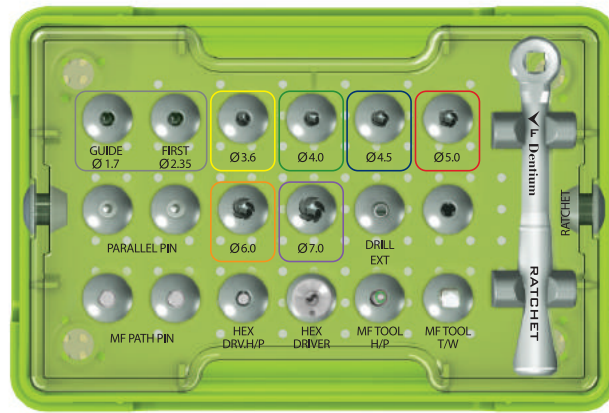

## SuperLine Short Implant Surgical Kit

XSIIK

### Kit Includes

First Guide Drill



XLD2207

Second Guide Drill



XLD2607

Final Drill



XFC3607



XFC4007



XFC4507



XFC5007

Parallel Pin



XPP162212



XFC6007



XFC7007

MF Path Pin



XMFPA2



Hex Driver



XHD25H



XHD26T

Hand-piece Adapter



XFA27H



XFA26W

Ratchet



XRCA1

# Stopper Drill Kit



## Stopper Drill Kit

XSDK

### Kit Includes

Guide Stopper

First

Second

Final Drill  
Stopper



XLD2208S



XLD2608S



XFD3408S



XFD3808S



XFD4308S



XFD4808S



XLD2210S



XLD2610S



XFD3410S



XFD3810S



XFD4310S



XFD4810S



XLD2212S



XLD2612S



XFD3412S



XFD3812S



XFD4312S



XFD4812S

# Drill Stopper Kit

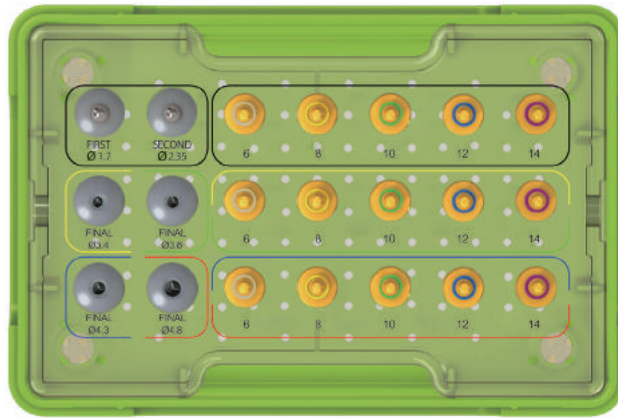

## Drill Stopper Kit

XDS

### Kit Includes

Guide Drill Stopper  
First                  Second

XLD2235                  XLD2635

Stopper - First Guide Drill, Second Guide Drill

XLDST06    XLDST08    XLDST10    XLDST12    XLDST14

Final Drill Stopper  
34                      38

XFD3435                  XFD3835

Stopper - Final Drill / 34, 38

XFDST06    XFDST08    XFDST10    XFDST12    XFDST14

Final Drill Stopper  
43                      48

XFD4335                  XFD4835

Stopper - Final Drill / 43, 48

XFDST06L    XFDST08L    XFDST10L    XFDST12L    XFDST14L

# Surgical Instruments

Unit: mm, Scale 1 : 1

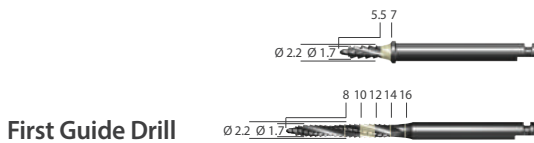

## First Guide Drill

Diameter	L	Art. No.
Ø 2.2	26	XLD 22 07
	29	XLD 22 29
	31	XLD 22 31
	33	XLD 22 33
	35	XLD 22 35
	41	XLD 22 41

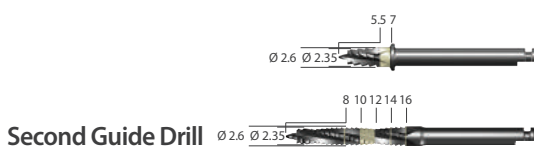
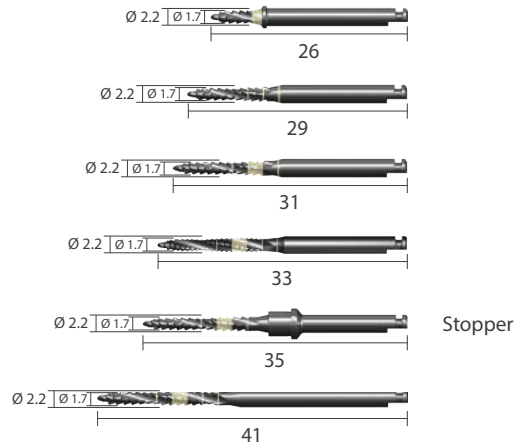

## Second Guide Drill

Diameter	L	Art. No.
Ø 2.6	26	XLD 26 07
	29	XLD 26 29
	31	XLD 26 31
	33	XLD 26 33
	35	XLD 26 35
	41	XLD 26 41

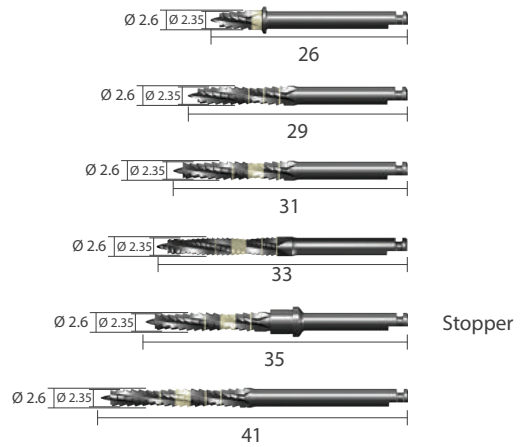

※ Note: Drill speed 1,000rpm, 30~45 N-cm with irrigation

# Surgical Instruments

Unit: mm, Scale 1 : 1

**Final Drill**



Diameter	L	Art. No.
Ø 2.9	29	XFD 34 29
Ø 3.35		XFD 38 29
Ø 3.85		XFD 43 29
Ø 4.4		XFD 48 29
Ø 5.4		XFD 58 29 SW

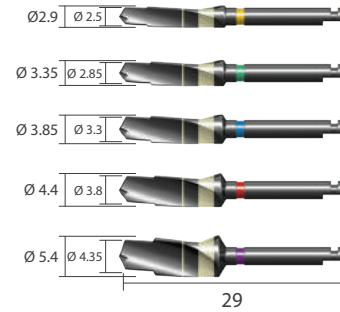

**Final Drill**



Diameter	L	Art. No.
Ø 2.9	31	XFD 34 31
Ø 3.35		XFD 38 31
Ø 3.85		XFD 43 31
Ø 4.4		XFD 48 31
Ø 5.4		XFD 58 31

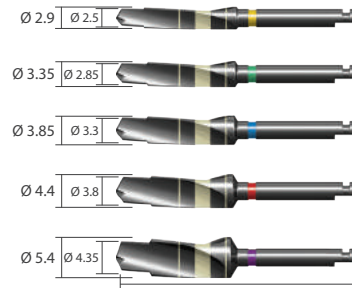

**Final Drill**



Diameter	L	Art. No.
Ø 2.9	33	XFD 34 33
Ø 3.35		XFD 38 33
Ø 3.85		XFD 43 33
Ø 4.4		XFD 48 33

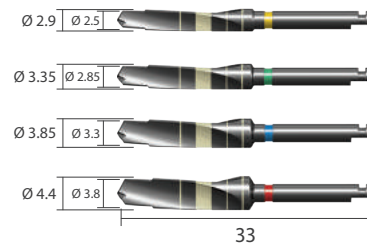

※ Note: Drill speed 1,000rpm, 30~45 N·cm with irrigation

# Surgical Instruments

Unit: mm, Scale 1 : 1

## Final Drill | Stopper



Diameter	L	Art. No.
Ø 2.9	35	XFD 34 35
Ø 3.35		XFD 38 35
Ø 3.85		XFD 43 35
Ø 4.4		XFD 48 35

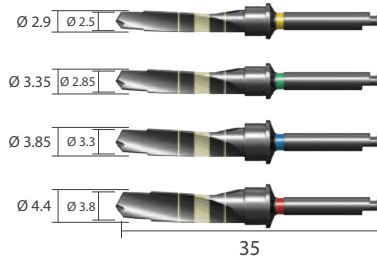

## Final Drill

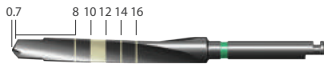

Diameter	L	Art. No.
Ø 2.9	41	XFD 34 41
Ø 3.35		XFD 38 41
Ø 3.85		XFD 43 41
Ø 4.4		XFD 48 41

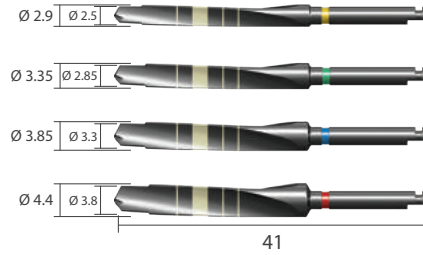

## Harvest Drill | Stopper



Diameter	L	Art. No.
Ø 2.85	35	XFH 34 35
Ø 3.3		XFH 38 35
Ø 3.85		XFH 43 35
Ø 4.4		XFH 48 35

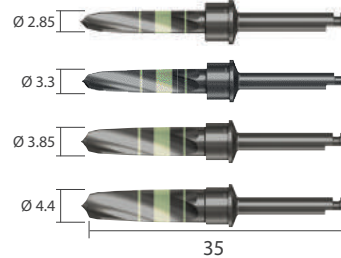

## Final Drill | For Short Drill



Diameter	L	Art. No.
Ø 3.6	27	XFC 36 07
Ø 4.0		XFC 40 07
Ø 4.5		XFC 45 07
Ø 5.0		XFC 50 07
Ø 6.0		XFC 60 07
Ø 7.0		XFC 70 07

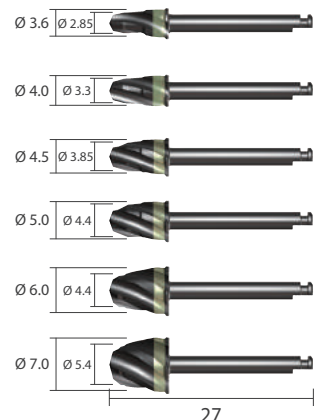

※ Note: Drill speed 1,000rpm, 30~45 N-cm with irrigation

# Surgical Instruments

Unit: mm, Scale 1 : 1

## First Drill | Stopper

Platform	Body	L	Art. No.
Ø 2.20	Ø 1.7	8	XLD 2208S
		10	XLD 2210S
		12	XLD 2212S

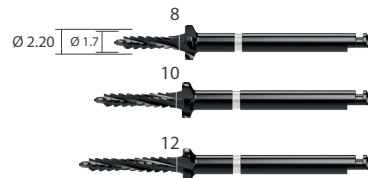

## Second Drill | Stopper

Platform	Body	L	Art. No.
Ø 2.60	Ø 2.35	8	XLD 2608S
		10	XLD 2610S
		12	XLD 2612S

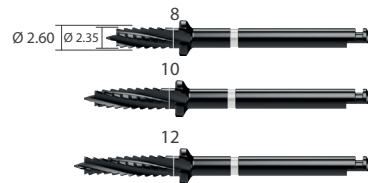

## Final Drill | Stopper

Ø 3.10	Ø 2.55	8	XFD 3408S
		10	XFD 3410S
		12	XFD 3412S

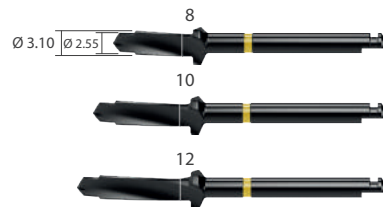

Ø 3.55	Ø 3.05	8	XFD 3808S
		10	XFD 3810S
		12	XFD 3812S



Ø 3.95	Ø 3.50	8	XFD 4308S
		10	XFD 4310S
		12	XFD 4312S



Ø 4.50	Ø 3.90	8	XFD 4808S
		10	XFD 4810S
		12	XFD 4812S





# Surgical Instruments

Unit: mm, Scale 1 : 1

## Countersink



Diameter	L	Art. No.
Ø 3.6	29	XCS 36 29 SW
Ø 4.0	29	XCS 40 29 SW
Ø 4.5	29	XCS 45 29 SW
Ø 5.0	29	XCS 50 29 SW
Ø 6.0	27	XCS 60 29 SW
Ø 7.0	27	XCS 70 29 SW

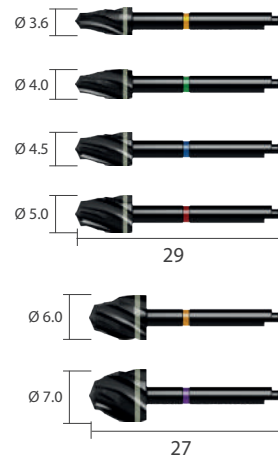

## Condensing Drill



Diameter	L	Art. No.
Ø 3.6	33	XCD 36 33
Ø 4.0	33	XCD 40 33
Ø 4.5	33	XCD 45 33
Ø 5.0	33	XCD 50 33
Ø 6.0	31	XCD 60 31
Ø 7.0	31	XCD 70 31

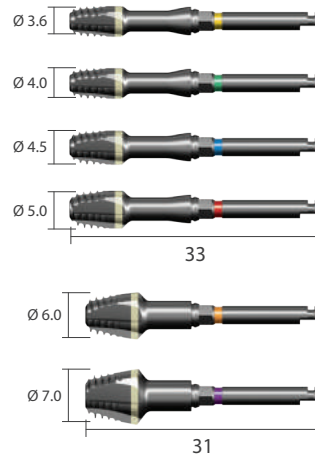

## Round Bur

Diameter	L	Art. No.
Ø 2.0	33	XRB 20 33
Ø 3.0		XRB 30 33



※ Note: 1. Countersink Drill & Round Bur speed 1,000rpm, 30~45 N-cm with irrigation  
 2. Condensing Drill speed 20~60rpm, 30~45 N-cm with irrigation

# Surgical Instruments

Unit: mm, Scale 1 : 1

**Stopper I** | For first guide drill, second guide drill

Diameter	Drilling Depth	L	Art. No.
Ø 4.45	14	4.6	XLDST 14
	12	6.6	XLDST 12
	10	8.6	XLDST 10
	08	10.6	XLDST 08
	06	12.6	XLDST 06
	04	14.6	XLDST 04
	02	16.6	XLDST 02

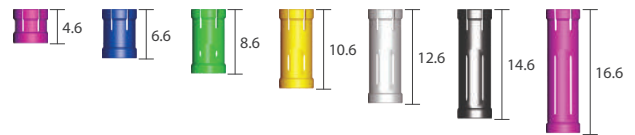

**Stopper I** | For final drill 3435, 3835

Diameter	Drilling Depth	L	Art. No.
Ø 5.14	14	4.6	XFDST 14
	12	6.6	XFDST 12
	10	8.6	XFDST 10
	08	10.6	XFDST 08
	06	12.6	XFDST 06
	04	14.6	XFDST 04
	02	16.6	XFDST 02

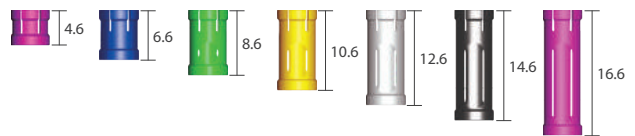

**Stopper I** | For final drill 4335, 4835

Diameter	Drilling Depth	L	Art. No.
Ø 5.14	14	4.6	XFDST 14 L
	12	6.6	XFDST 12 L
	10	8.6	XFDST 10 L
	08	10.6	XFDST 08 L
	06	12.6	XFDST 06 L
	04	14.6	XFDST 04 L
	02	16.6	XFDST 02 L

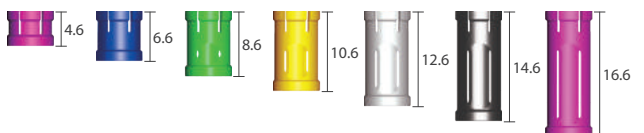

# Surgical Instruments

Unit: mm, Scale 1 : 1

## Adapter | Hex 2.5mm

Diameter	L	Art. No.
Hand-piece	27	XFA 27 H
	30	XFA 30 H
	32	XFA 32 H
Ratchet	24	XFA 24 W
	26	XFA 26 W
	29	XFA 29 W
	32	XFA 32 W

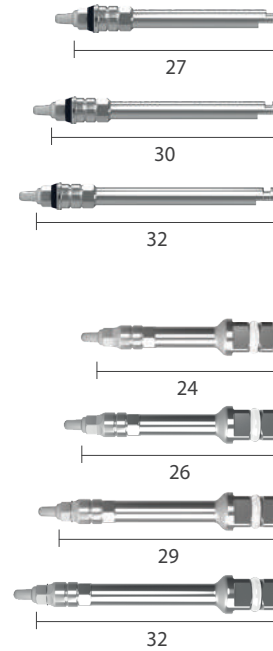

## Parallel Pin | For first guide drill, second guide drill

Diameter	L	Art. No.
Ø 1.6	15.5	XPP 162212
	20	XPP 162220 T
	26	XPP 162226 T

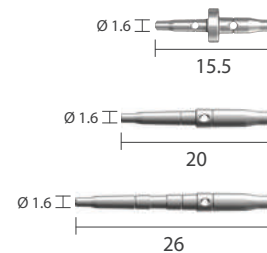

## Path Pin

Diameter	L	Art. No.
Ø 1.6	18.6	XMFP A 2



## Slot Driver

Type	L	Art. No.
Ratchet	17	SDA 17 R
	25	SDA 25 R

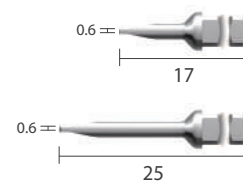

# Surgical Instruments

Unit: mm, Scale 1 : 1

## Hex Driver | Hex 1.28mm

Type	L	Art. No.
<b>Hand-piece</b>	25	XHD 25 H
<b>Ratchet</b>	21	XHD 21 W
	25	XHD 25 W
	27	XHD 27 W
<b>Manual</b>	26	XHD 26 T
	30	XHD 30 T

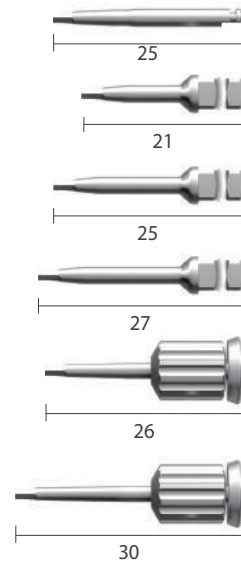

## Angled Hex Driver

Type	L	Art. No.
<b>Hand-piece</b>	25	XAD 25 H
<b>Ratchet</b>	21	XAD 21 W
	25	XAD 25 W
	27	XAD 27 W
<b>Manual</b>	26	XAD 26 T
	30	XAD 30 T

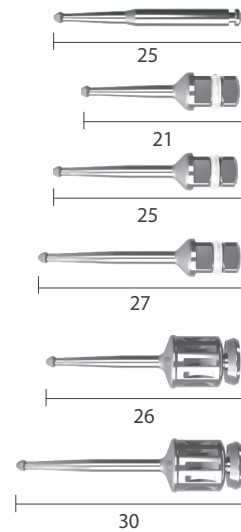

## Drill Extension

Diameter	L	Art. No.
Ø 3.0	26	XDE

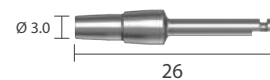

## Driver

Type	Diameter	Art. No.
<b>Manual</b>	Ø 12.0	XHDHT

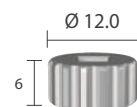

# Surgical Instruments

Unit: mm, Scale 1 : 1

## Screw & Ball Abutment Adapter

Type	L	Art. No.
Hand-piece	20	XMAA 1
Ratchet	21	XMA 21 W

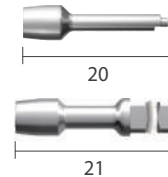

## Mini Ball Abutment Adapter

Type	L	Art. No.
Ratchet	21	IPST 21 W

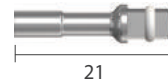

Ratchet	Scale 0.7 : 1
XRCA 1	



Torque Wrench	Scale 0.7 : 1
XNTW	



Depth Gauge	Scale 0.7 : 1
XDGL	

※ Note: One side of Depth Gauge measures the osteotomy depth and the other side measures the gingival height from the top of the implant.

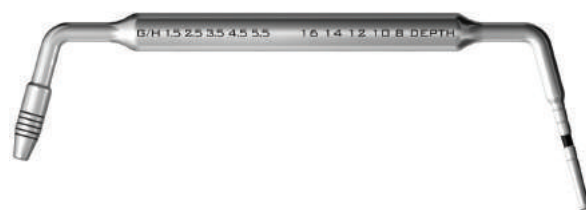

## Tissue Punch

Diameter	L	Art. No.
Ø 4.0	27	XTS 40

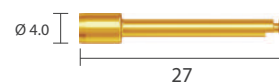

# DASK

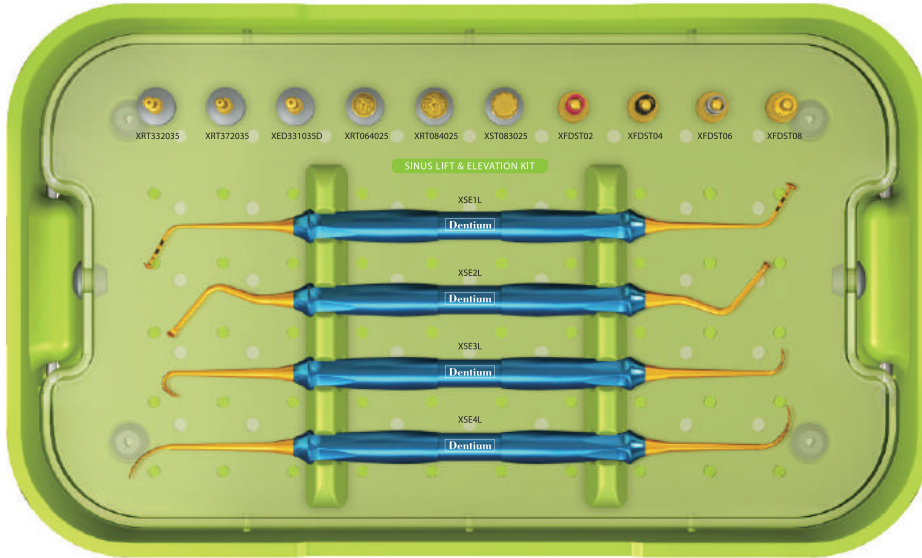

## Dentium Advanced Sinus Kit

## DASK

### Kit Includes

#### DASK Drill



#### Stopper



#### Sinus Elevation Instrument



# Sinus Bur Kit

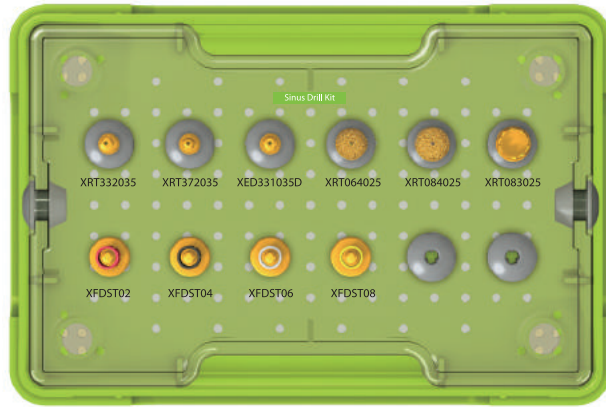

## Sinus Bur Kit

SDK

### Kit Includes

#### DASK Drill



#### Stopper





# DASK / Sinus Bur Kit

Unit: mm, Scale 1 : 1

## DASK Drill

Type	DASK Drill #	Art. No.
<b>Crestal Approach</b>	DASK Drill #1	XRT 33 20 35
	DASK Drill #2	XRT 37 20 35
	DASK Drill #3	XED 33 10 35 D
<b>Lateral Approach</b>	DASK Drill #4	XRT 06 40 25
	DASK Drill #5	XRT 08 40 25
	DASK Drill #6	XST 08 30 25

※ Note: Drill speed 800 to 1,200rpm, 30~45N-cm with irrigation

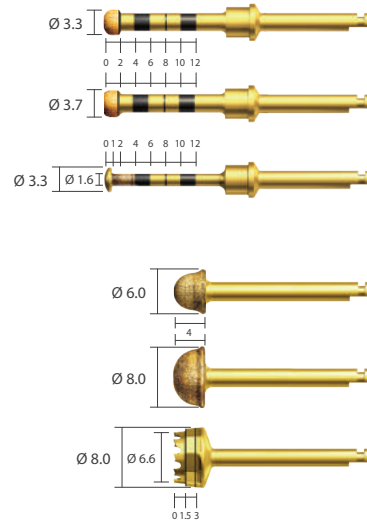

## Stopper | For XRT332035, XRT372035, XED331035D

Diameter	Drilling Depth	L	Art. No.
Ø 5.14	08	10.6	XFDST 08
	06	12.6	XFDST 06
	04	14.6	XFDST 04
	02	16.6	XFDST 02



## Sinus Elevation Instrument | Scale 0.45 : 1

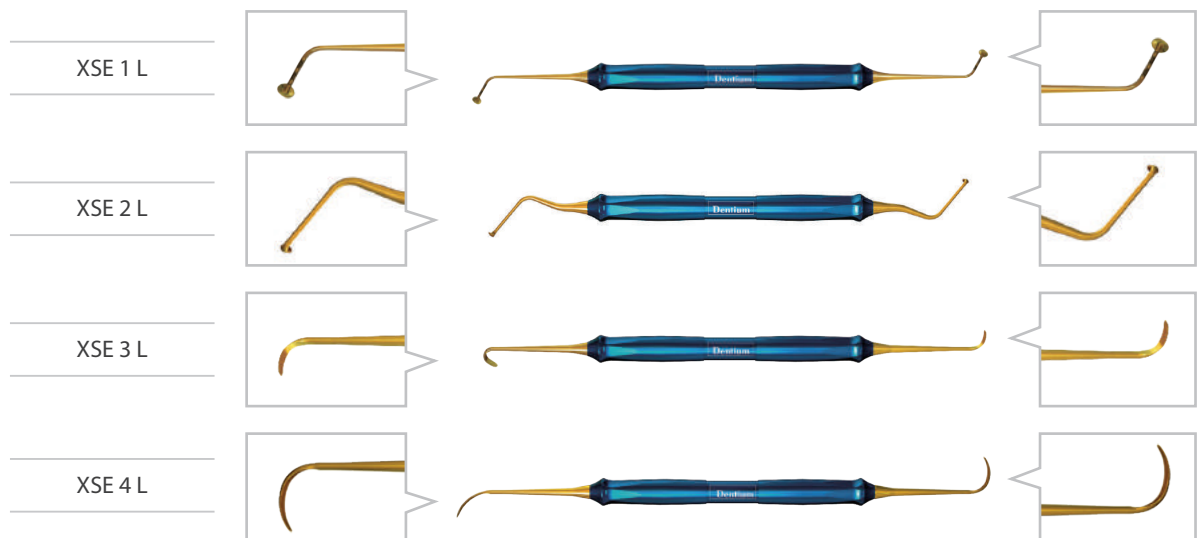

# Osteotome Kit

Unit: mm, Scale 1 : 1

## Osteotome

Osteotome compresses the bone laterally, providing denser bony interface rather than removing valuable bone from the surgical site.

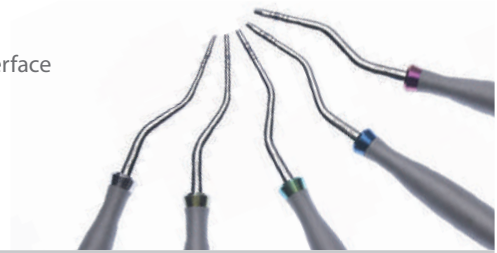

## Osteotome Kit

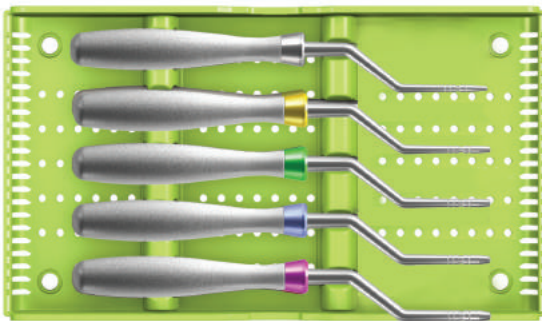

XOFK Type A (Convex)	XOFBK Type B (Concave)
XOF 20 A1	XOF 20 B1
XOF 34 A1	XOF 34 B1
XOF 38 A1	XOF 38 B1
XOF 43 A1	XOF 43 B1
XOF 48 A1	XOF 48 B1

## Osteotome | Final drill type | Scale 0.4 : 1

Type	Ø A	Ø B	Art. No.
<b>Type A</b> (Convex)	Ø 1.7	Ø 2.8	XOF 20 A1
	Ø 2.3	Ø 2.8	XOF 34 A1
	Ø 2.7	Ø 3.2	XOF 38 A1
	Ø 2.8	Ø 3.8	XOF 43 A1
	Ø 3.0	Ø 4.3	XOF 48 A1
<b>Type B</b> (Concave)	Ø 1.7	Ø 2.8	XOF 20 B1
	Ø 2.3	Ø 2.8	XOF 34 B1
	Ø 2.7	Ø 3.2	XOF 38 B1
	Ø 2.8	Ø 3.8	XOF 43 B1
	Ø 3.0	Ø 4.3	XOF 48 B1

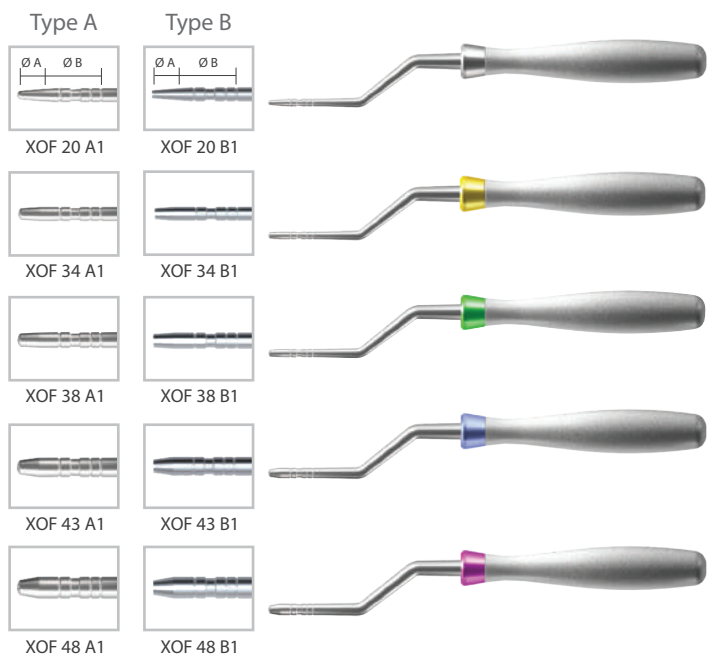

# Trephine Kit

Unit: mm, Scale 1 : 1

## Trephine Bur

- Excellent fine cutting
- Strong engagement when attaching the trephine to cortical bone
- Cut-outs facilitates ease of harvest retrieval
- 5 scale marks on the Trephine drill from 2mm to 10mm
- Easy harvesting

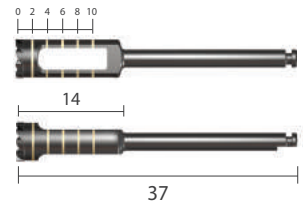

## Trephine Kit

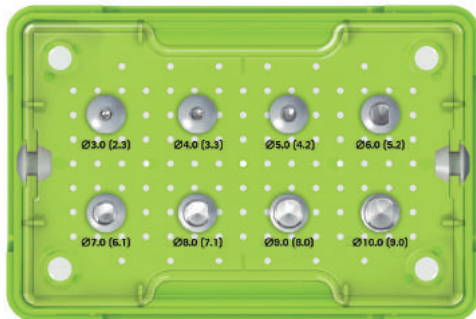

XIT

Kit Includes

XTP 24 03	XTP 34 04	XTP 44 05	XTP 54 06
XTP 64 07	XTP 74 08	XTP 84 09	XTP 94 10

## Trephine Bur

Outer Diameter	Inner Diameter	Art. No.
Ø 3.0	Ø 2.3	XTP 24 03
Ø 4.0	Ø 3.3	XTP 34 04
Ø 5.0	Ø 4.2	XTP 44 05
Ø 6.0	Ø 5.2	XTP 54 06
Ø 7.0	Ø 6.1	XTP 64 07
Ø 8.0	Ø 7.1	XTP 74 08
Ø 9.0	Ø 8.0	XTP 84 09
Ø 10.0	Ø 9.0	XTP 94 10

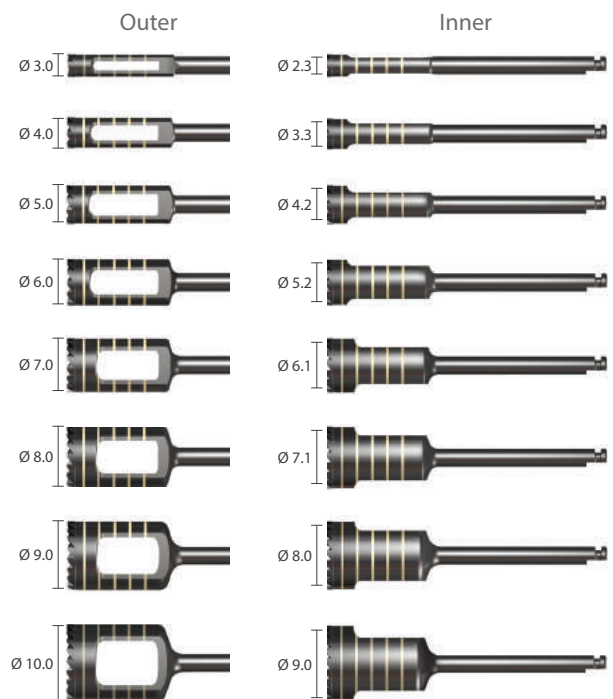

# Instrument

Unit: mm, Scale 1 : 1.5

## Screw Drill

Diameter	Art. No.
Ø1.2	GMD 1228



## Membrane screw insertion tool

[ Unit: mm, Scale 1 : 0.7 ]

Art. No.
GST26H
GST56
GST85
COD



**GST 26H**



**GST 56**



**GST 85**



**COD**

# Membrane Pins

Unit: mm, Scale 1 : 2

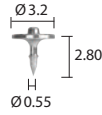

L	Art. No.
2.80	GMT3225

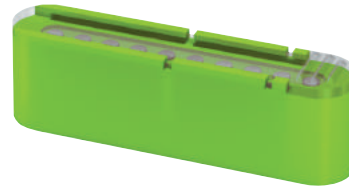

Pin case | Pin 10ea included



L	Art. No.
125.0	GMNT



Membrane Pin with insertion tool

# Membrane Screws

Unit: mm, Scale 1 : 2

## Screw

L	Art. No.
2.5	GSC 15 <b>02</b>
4.0	GSC 15 <b>04</b>
6.0	GSC 15 <b>06</b>
8.0	GSC 15 <b>08</b>
10.0	GSC 15 <b>10</b>

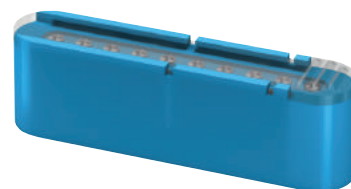
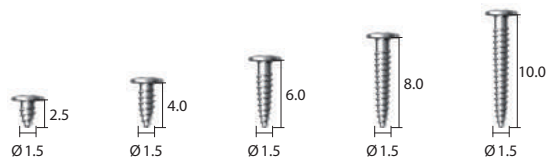

Screw case | Screw 10ea included

# Prosthetic Kit

Unit: mm, Scale 1 : 1

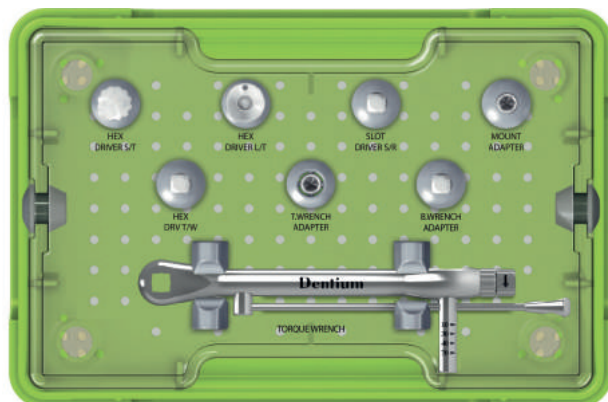

## XIP

### Hex Driver

Type	L	Art. No.
S/T	15	XHD 15
L/T	30	XHD 30 T
Torque Wrench	25	XHD 25 W



### Adapter

Type	L	Art. No.
Torque Wrench	21	XMA 21 W
Mini Ball	21	IPST 21 W
Mount	20	XMAA 1

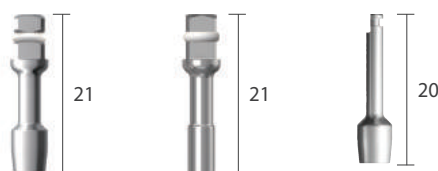

### Slot Driver

SDA 25 R



### Torque Wrench

Scale 0.7 : 1

XNTW



# Planning Kit

Unit: mm, Scale 1 : 1

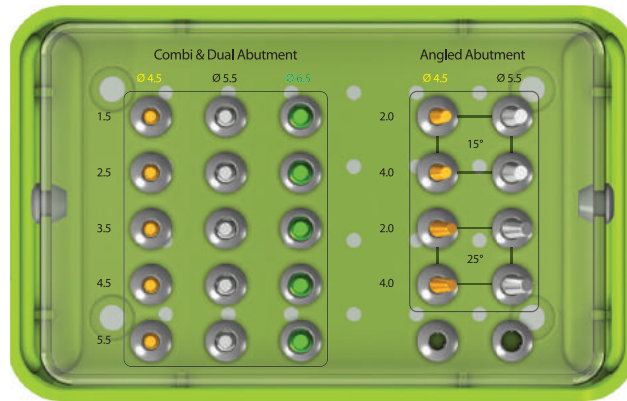

## XPK

### For Combi & Dual Abutment

Diameter	G/H	Art. No.
Ø 4.5	1.5	PDAB 45 15
	2.5	PDAB 45 25
	3.5	PDAB 45 35
	4.5	PDAB 45 45
	5.5	PDAB 45 55
Ø 5.5	1.5	PDAB 55 15
	2.5	PDAB 55 25
	3.5	PDAB 55 35
	4.5	PDAB 55 45
	5.5	PDAB 55 55
Ø 6.5	1.5	PDAB 65 15
	2.5	PDAB 65 25
	3.5	PDAB 65 35
	4.5	PDAB 65 45
	5.5	PDAB 65 55

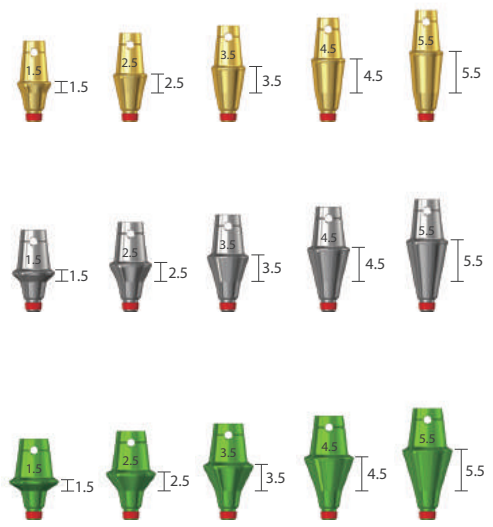

### For Angled Abutment

Angled	Diameter	G/H	Art. No.
15°	Ø 4.5	2.0	PAAB 15 45 20
		4.0	PAAB 15 45 40
	Ø 5.5	2.0	PAAB 15 55 20
		4.0	PAAB 15 55 40
25°	Ø 4.5	2.0	PAAB 25 45 20
		4.0	PAAB 25 45 40
	Ø 5.5	2.0	PAAB 25 55 20
		4.0	PAAB 25 55 40

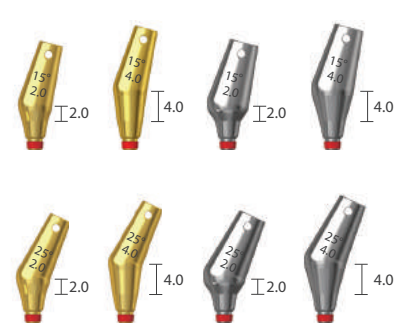



# Prosthetic and Laboratory Instrument

Unit: mm, Scale 1 : 1

## Hex Driver

Hex	L	Art. No.
1.28	13	XHD 13
	15	XHD 15
	21	XHD 21
	28	XHD 28

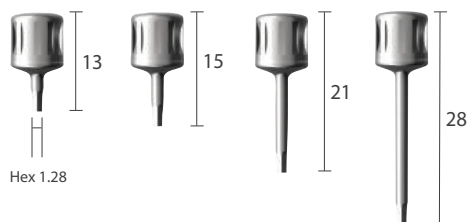

## Reamer Guide

Application	Diameter	Art. No.
Combi / Dual Abutment	Ø 4.5	CRG 45 L
	Ø 5.5	CRG 55 L
	Ø 6.5	CRG 65 L

Application	Type	Art. No.
Screw Abutment	Bridge	SRG BL
	Single	SRG SL

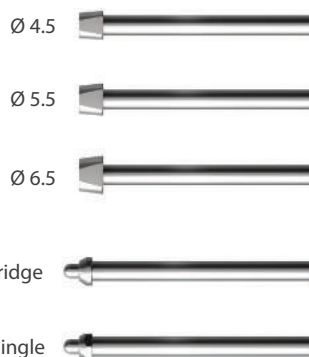

## Reamer Handle

Scale 0.5 : 1

CRH
-----



## Hand Wrench

XHW
-----



## Reamer

Application	Art. No.
Combi / Dual Abutment	CRM
Screw Abutment	SRM



# Help Kit

Unit: mm, Scale 1 : 1

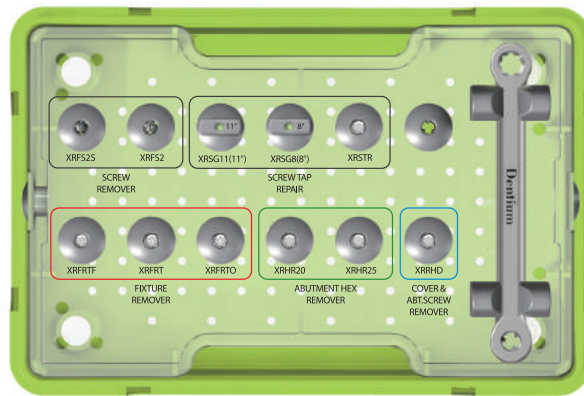

## XIH

### Screw Remover

L	Art. No.
25	XRFS 2 S
33	XRFS 2

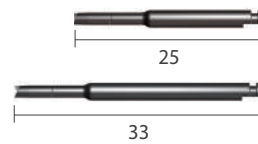

### Screw Tap Repair

Type	Art. No.
Tap	XRSTR
11° Guide	XRSG 11
8° Guide	XRSG 8

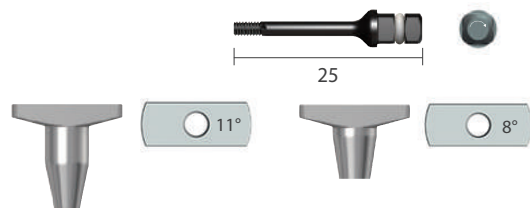

### Fixture Remover

Type	Art. No.
-	XRFRT
11°	XRFRTF
8°	XRFRT0

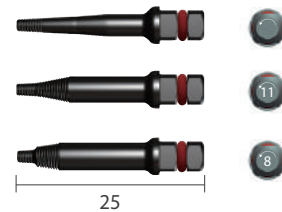

### Abutment Hex Remover

L	Art. No.
20	XRHR 20
25	XRHR 25

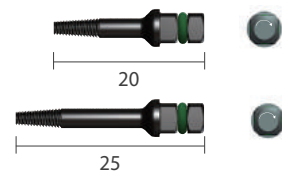

### Cover & Abutment Screw Remover

L	Art. No.
25	XRRHD



### Wrench

Scale 1 : 0.7

XRFRW

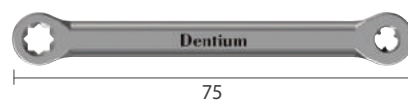

# Polymer Guide Kit

Unit: mm, Scale 1 : 1

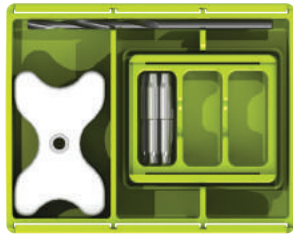

PGSSK

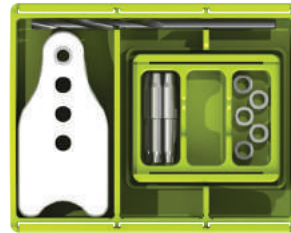

PGSCK

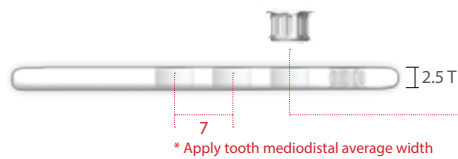
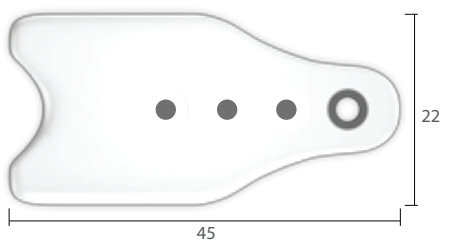
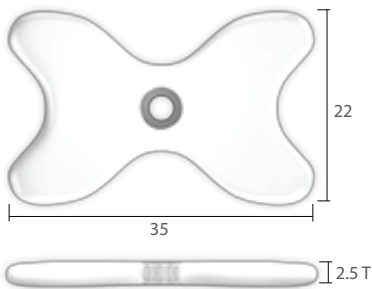

\* Apply tooth mediobuccal average width

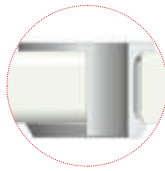

\* 1 fixed Sleeve + 3 additional Sleeve Hole

## Single Standard (5ea)

T	Art. No.
2.5	XSG 34 <b>35</b> S

## Cantilever Multi-Ready (5ea)

T	Art. No.
2.5	XSG 34 <b>45</b> C

· Stone Drill



XGD **23 60** (1ea)

· Guide Pin



XGP **34 23** S (5ea)

· Additional Metal Sleeve  
(for Cantilever Multi-Ready)



XPGS **34 25** A (5ea)

# Sinus Kit

Unit: mm, Scale 1 : 1

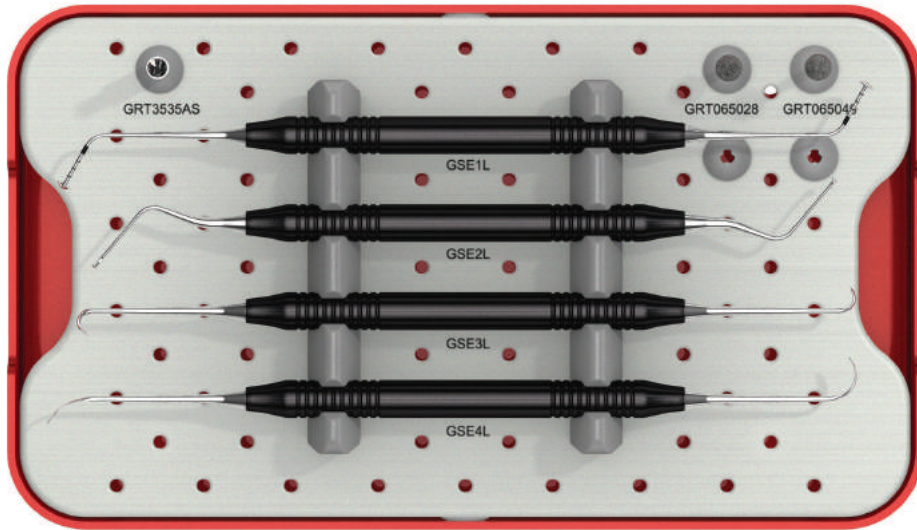

## GSEK

### Crestal Drill

Diameter	L	Art No.
Ø3.5	35	GRT 35 35 AS

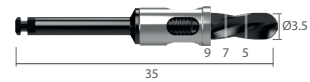

### Lateral Drill

Diameter	L	Art No.
Ø6.0	28	GRT 06 50 28
Ø6.0	40	GRT 06 50 40

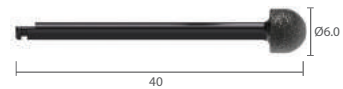

### Sinus Curette Scale 1 : 2 / mm



# Ridge Expander Kit

Unit: mm, Scale 1 : 1

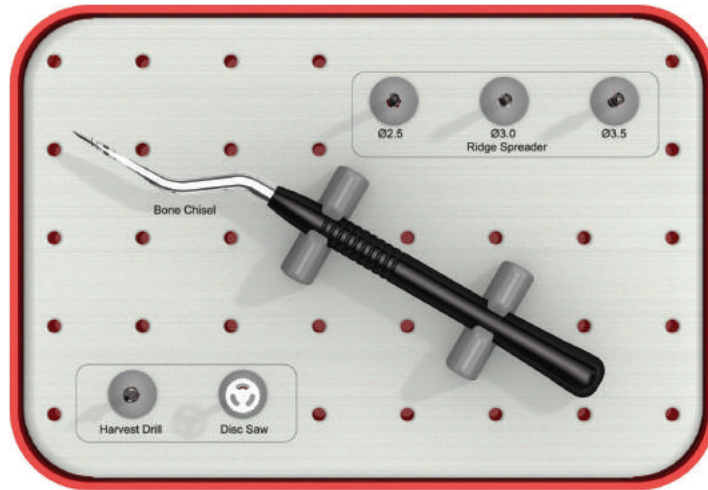

## GREK

### Ridge Spreader

Diameter	L	Art No.
Ø1.3 / Ø2.5	32	GRS 13 25
Ø1.8 / Ø3.0	32	GRS 18 30
Ø2.3 / Ø3.5	32	GRS 23 35

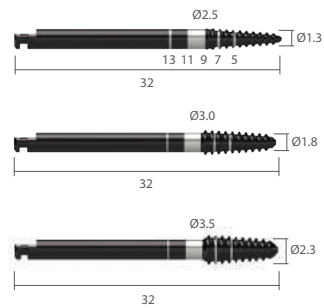

### Harvest Drill

Diameter	L	Art No.
Ø3.0	29	GHD 30 29

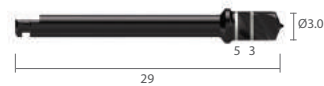

### Disc Saw

Diameter	L	Art No.
Ø8.0	25	GDS 80 25

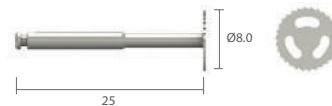

### Bone Chisel

Art No.	GBC 18 45 13
---------	--------------



# Implant Guide Kit

Unit: mm, Scale 1 : 1

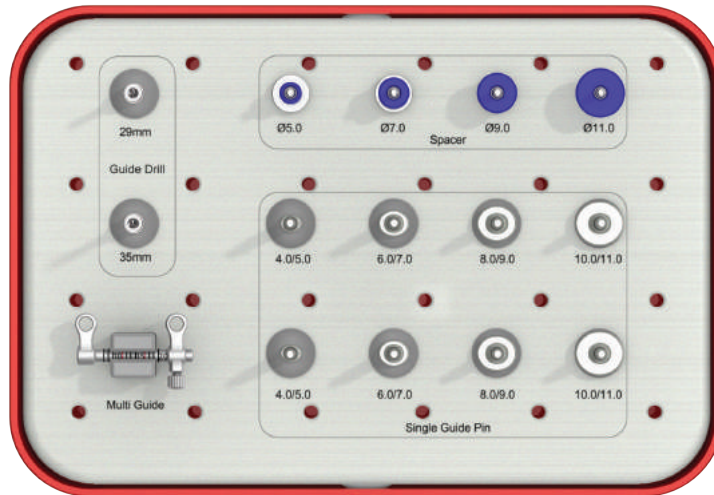

## GIGK

### Guide Drill

Diameter	L	Art No.
Ø2.6	29	GGD 26 29
Ø2.6	35	GGD 26 35

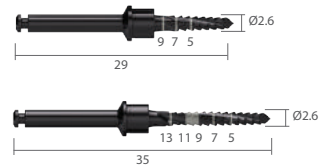

### Spacer

Width	Art No.
5.0	GSP 05
7.0	GSP 07
9.0	GSP 09
11.0	GSP 11



### Single Guide Pin

Width	Art No.
4.0 / 5.0	GGP 04 05
6.0 / 7.0	GGP 06 07
8.0 / 9.0	GGP 08 09
10.0 / 11.0	GGP 10 11

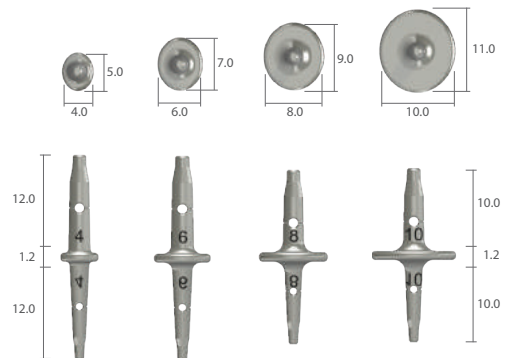

### Multi Guide

Art No.	GMG2
---------	------





# Digital Full Kit

Unit: mm, Scale 1 : 1

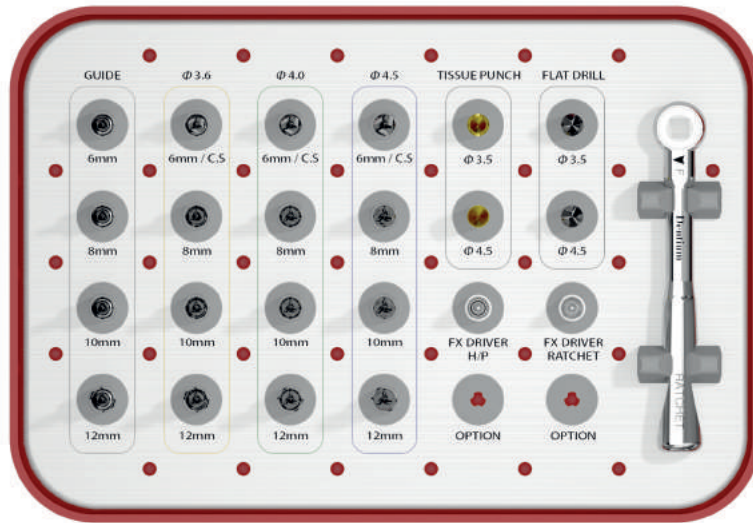

## XGSFK

### SuperLine FX4508SW Guide Drilling Sequence

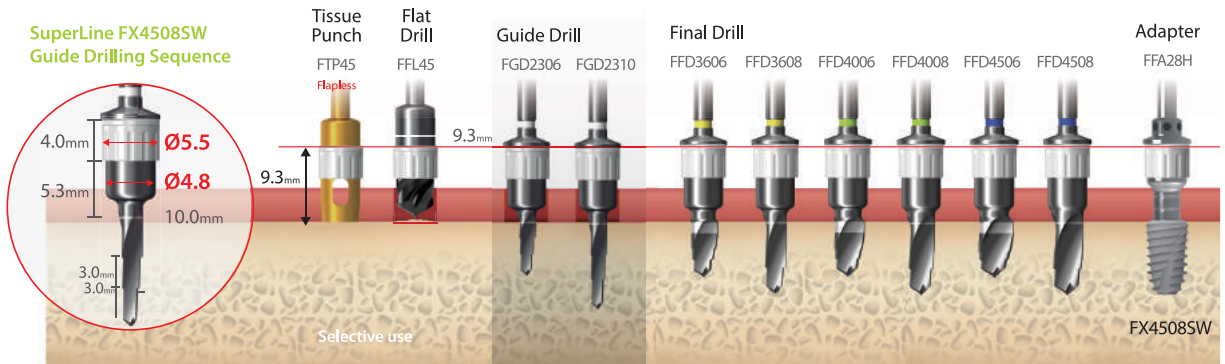

<div style="border: 1px solid black; border-radius: 10px; padding: 2px; width: fit-content; margin: 0 auto;">Guide Drill</div> <p>FGD2306 FGD2308 FGD2310 FGD2312</p>	<div style="border: 1px solid black; border-radius: 10px; padding: 2px; width: fit-content; margin: 0 auto;">FX 36 Final Drill</div> <p>FFD3606 FFD3608 FFD3610 FFD3612</p>	<div style="border: 1px solid black; border-radius: 10px; padding: 2px; width: fit-content; margin: 0 auto;">FX 40 Final Drill</div> <p>FFD4006 FFD4008 FFD4010 FFD4012</p>	<div style="border: 1px solid black; border-radius: 10px; padding: 2px; width: fit-content; margin: 0 auto;">FX 45 Final Drill</div> <p>FFD4506 FFD4508 FFD4510 FFD4512</p>	
<b>Tissue Punch</b> <p>FTP35 FTP45</p>	<b>Flat Drill</b> <p>FLL35 FLL45</p>	<b>Fixture Adapter</b> <p>FFA28H FFA28W FFA30H FFA30W</p>	<b>Ti-Sleeve</b> <p>FMS49 FOS49</p>	<b>Ratchet</b> <p>XRCA1</p>



# Digital Simple Kit

Unit: mm, Scale 1 : 1

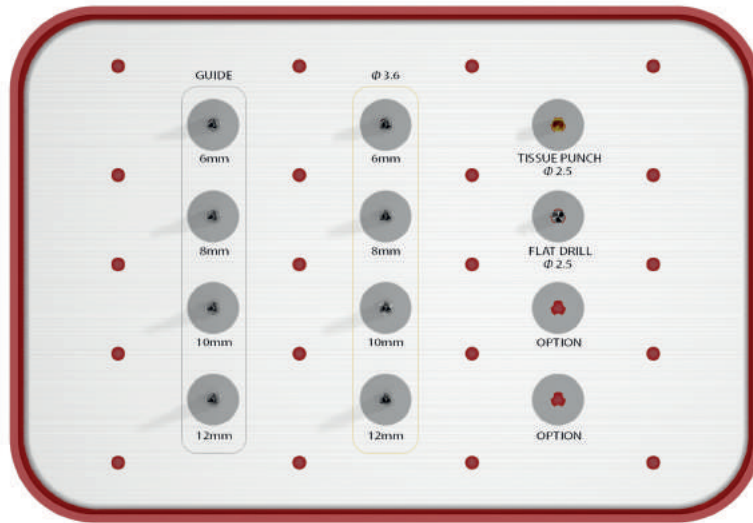

## XGSSK

### SuperLine FX3608SW Guide Drilling Sequence

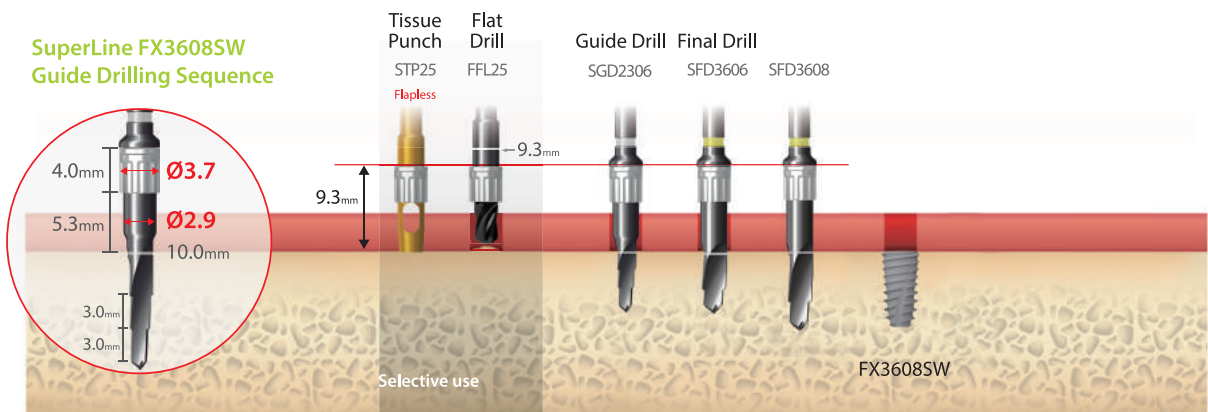

### Guide Drill

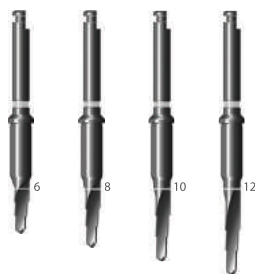

SGD2306 SGD2308 SGD2310 SGD2312

### FX 36 Final Drill

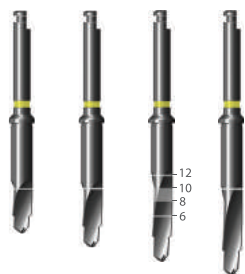

SFD3606 SFD3608 SFD3610 SFD3612

### Tissue Punch



STP25

### Flat Drill



SFL25

### Ti-Sleeve



SMS30

### Ti-Open Sleeve



SOS30

**Dentium**  
For Dentists By Dentists

**Dentium**  
For Dentists By Dentists

# SuperLine

## Product Catalog

**Dentium**  
For Dentists By Dentists

Specifications are subject to change without any notice.  
Some products listed in this catalog are not available in the market due to pending approval.

**HEAD OFFICE**

174-10, #821 (Gangnam Ace Tower), Jagok-ro, Gangnam-gu, Seoul, Republic of Korea Tel +82-2-555-3750 Fax +82-2-501-9571

**HOME PAGE**

[www.dentium.co.kr](http://www.dentium.co.kr)

SIPC-1906[Rev.1]