

**Dentium Instruments**  
for Total Solution

Catalog & Manual

## Index

Surgical Guide	<b>Polymer Guide</b>	04
	<b>Implant Guide</b>	06
Sinus Instruments	<b>DASK</b>	11
	<b>Osteotome Kit</b>	16
	<b>Sinus Elevator</b>	17
GBR Instruments	<b>RS Kit</b>	19
	<b>Harvest Drill</b>	24
Others	<b>Help Kit</b>	27
	<b>Temporary Shell</b>	34
	<b>White Seal</b>	36

The image shows a dental surgical guide on a model. The guide is a light-colored, semi-transparent polymer with a central hole. A metal drill bit is inserted into this hole. The background is a soft, out-of-focus light blue. The text 'Surgical Guide' is printed in white, bold font on the right side of the image. Below it, the words 'Polymer Guide' and 'Implant Guide' are printed in a smaller, red, italicized font.

# Surgical Guide

*Polymer Guide  
Implant Guide*

# Polymer Guide

## Thermoplastic Surgical Template for Dental Implant Placement

- Fabricate precise surgical template in just minutes using hot water
- Disposable material to promote control of infection and contamination
- Titanium sleeve is compatible with Dentium Guide and Final Drills



**Thermoplastic surgical template**  
Fabricate an accurate surgical template in just minutes, greatly reducing the lab and chairside time.

**Fully compatible with Dentium Drill System**

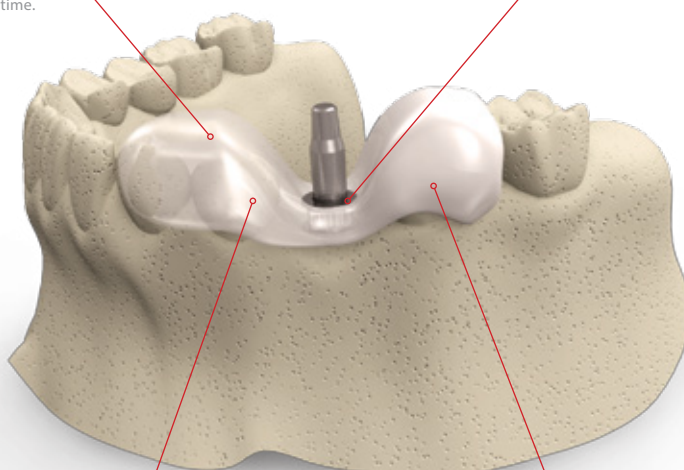

**Suitable template shape**

Polymer Guide is designed to maximize contact area over the adjacent teeth while allowing substantial field of view during implant surgery.

**Improved infection/contamination control**

To ensure infection/contamination-free surgery every time, the Polymer Guides are made to be disposable.



Drill a hole in the stone model



Insert the Guide Pin



Soak the Polymer Guide in hot water above 65°C to soften up the material for easy molding.



Apply of Polymer Guide on stone model

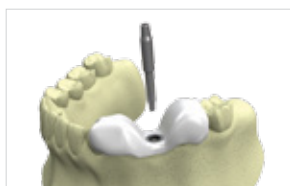

Remove the Guide Pin

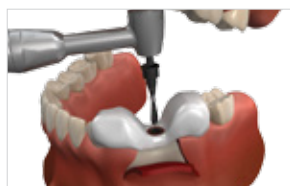

Position the Polymer Guide intra-orally for drilling

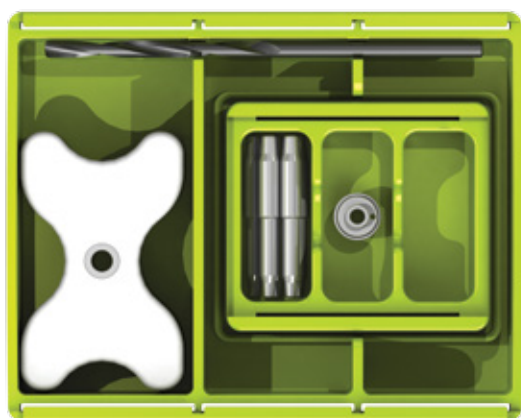

PGSSK



PGSCK

### Single Standard (5ea)

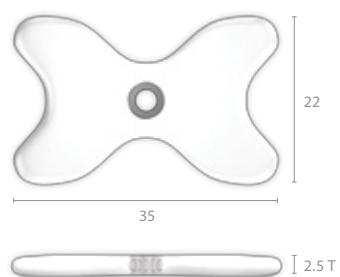



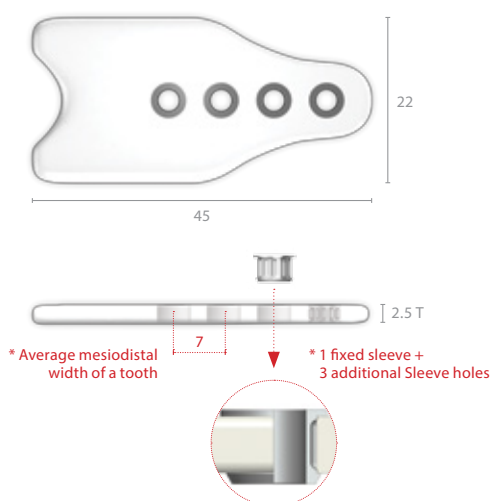

### Cantilever Multi-Ready (5ea)



[ Unit: mm, Scale 1 : 1 / mm ]

T	Art. No.
2.5	XSG 34 35 S

T	Art. No.
2.5	XSG 34 45 C

Stone Drill		XGD 23 60	(1ea)
Guide Pin		XGP 34 23 S	(5ea)
Guide Drill Brushing (First)		XPGB 19 26	(1ea)
Guide Drill Brushing (Second)		XPGB 26 34	(1ea)
Additional Metal Sleeve (for Cantilever Multi-Ready)		XPGS 34 25 A	(5ea)

# Implant Guide

## Surgical guide utilizing silicon spacer and unique parallel pin

- The tripod parallel pin is designed to take into consideration the mesiodistal width and drilling position in the edentulous area
- Parallel pins and Spacers are configured based on the average width of a tooth

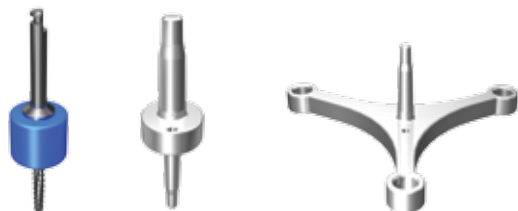

Assist in the implant positioning as well as determining the width and the position of the prosthetic components

The Guide Drill holes on the Tripod Parallel Pin help in prepping the osteotomy in the correct orientation

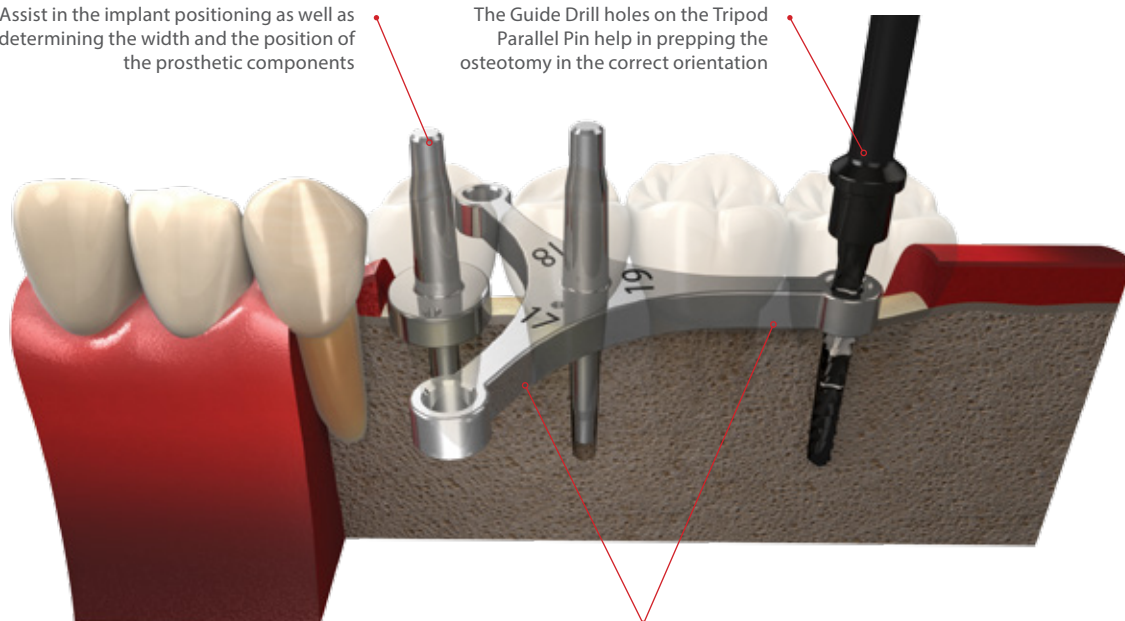

The three legs of the Tripod Parallel Pin are of different lengths to accommodate varying widths of prosthesis for multiple unit bridges

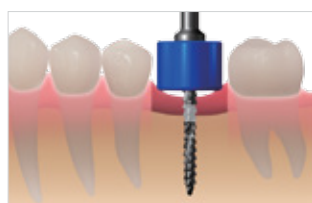

Spacer + Guide Drill

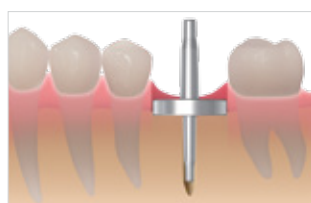

Ellipse Parallel Pin

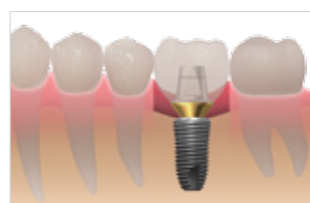

Final prosthesis

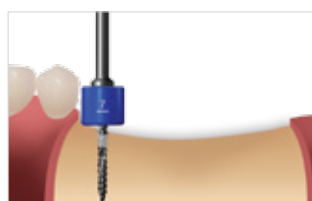

Spacer + Guide Drill

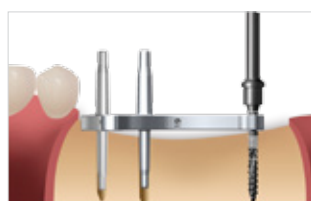

Ellipse Parallel Pin + Tripod Parallel Pin

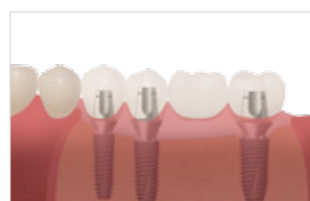

Final prosthesis

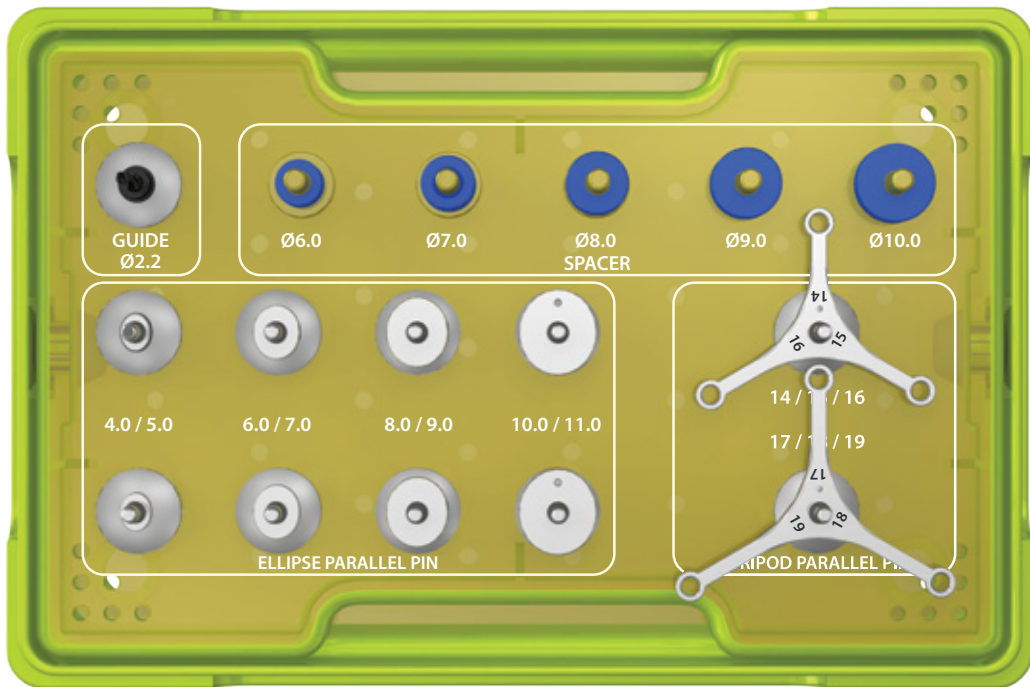

ISGK

**Kit Contents**

Guide Drill



XLD 22 355

Spacers



XLDSP 605

XLDSP 705

XLDSP 805

XLDSP 905

XLDSP 105

Ellipse Parallel Pins (x2)

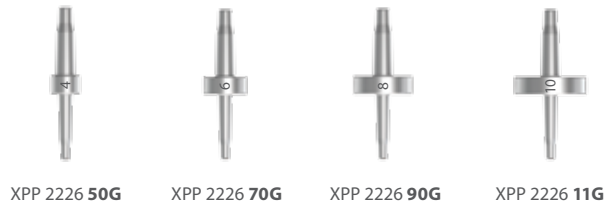

XPP 2226 50G

XPP 2226 70G

XPP 2226 90G

XPP 2226 11G

Tripod Parallel Pins

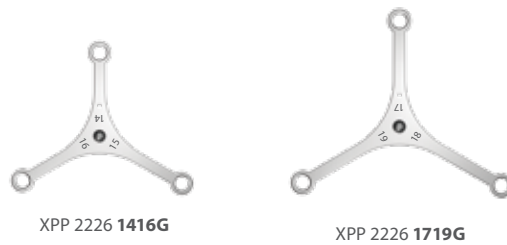

XPP 2226 1416G

XPP 2226 1719G

### Spacers

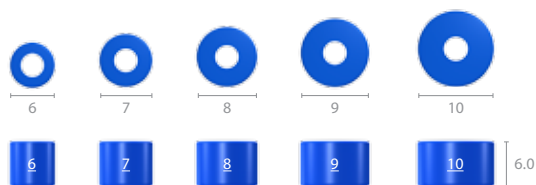

Diameter	Art. No.
Ø 6	XLDSP <b>60S</b>
Ø 7	XLDSP <b>70S</b>
Ø 8	XLDSP <b>80S</b>
Ø 9	XLDSP <b>90S</b>
Ø 10	XLDSP <b>10S</b>

### Ellipse Parallel Pins

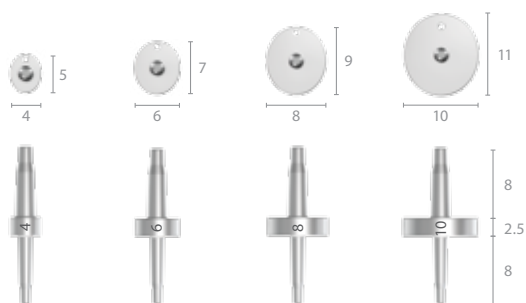

Diameter	Art. No.
Ø 4 / Ø 5	XPP 2226 <b>50G</b>
Ø 6 / Ø 7	XPP 2226 <b>70G</b>
Ø 8 / Ø 9	XPP 2226 <b>90G</b>
Ø 10 / Ø 11	XPP 2226 <b>11G</b>

### Tripod Parallel Pins

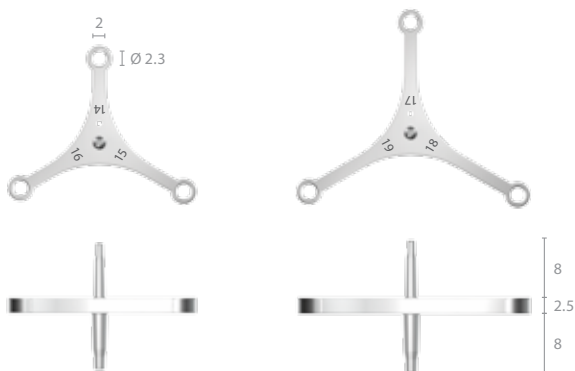

Width	Art. No.
14 / 15 / 16	XPP 2226 <b>1416G</b>
17 / 18 / 19	XPP 2226 <b>1719G</b>



### Single Case

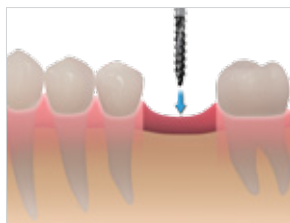

Incision

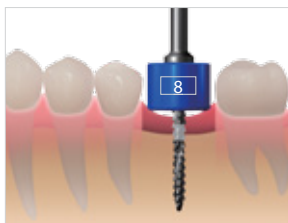

Guide Drill  
Combination of Guide Drill and  
Spacer

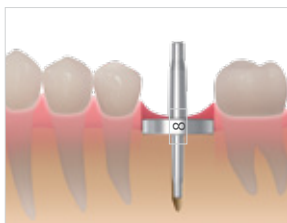

Ellipse Parallel Pin

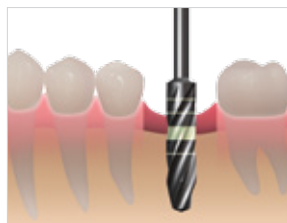

Final Drill

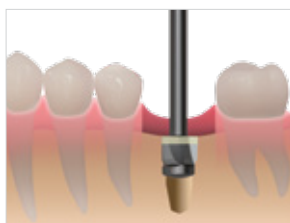

Countersink

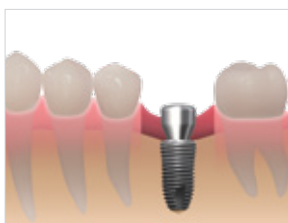

Fixture placement with  
Healing Abutment  
SuperLine

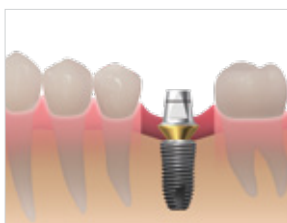

Dual Abutment Connection

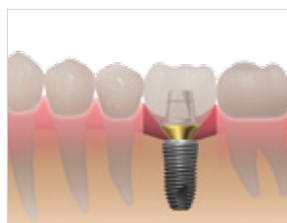

Final prosthesis

### Multiple Case

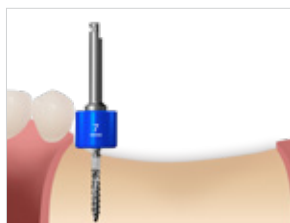

Guide Drill  
Combination of Guide Drill and  
Spacer

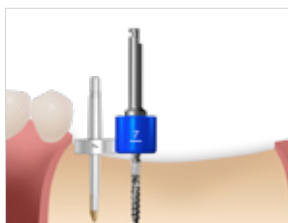

Guide Drill  
Application of Tripod and Ellipse Parallel Pin

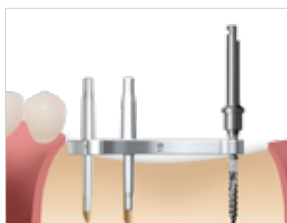

Dual Abutment connection

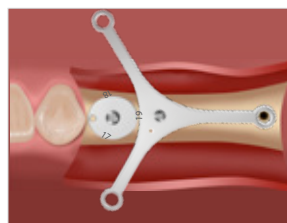

Final prosthesis

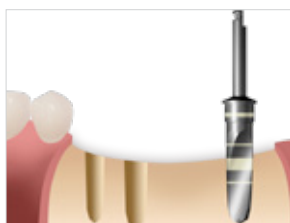

Final Drilling

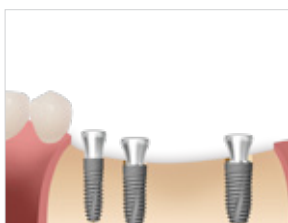

Fixture placement with  
Healing Abutment  
NR Line



# Sinus Instruments

*DASK  
Osteotome Kit  
Sinus Elevator*

# Dentium Advanced Sinus Kit (DASK)

- Simple & easy access to sinus cavity
- Broad exposure of bony walls with special instruments

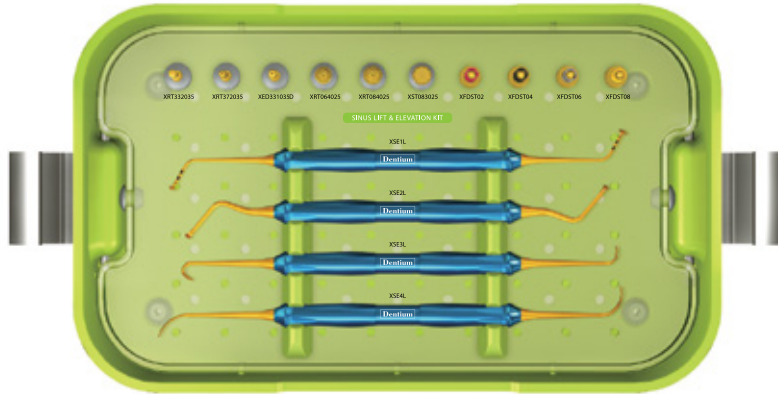

## DASK Drills



[Unit: mm, Scale 1 : 1.2 / mm]

Type	DASK Drill #	REF
Crestal Approach	DASK Drill # 1	XRT <b>33</b> 2035
	DASK Drill # 2	XRT <b>37</b> 2035
	DASK Drill # 3	XED <b>33</b> 1035D
Lateral Approach	DASK Drill # 4	XRT <b>06</b> 4025
	DASK Drill # 5	XRT <b>08</b> 4025
	DASK Drill v# 6	XRT <b>08</b> 3025

\* DASK Drill #1-5 : Drill speed 800 to 1,200 rpm, 30~45N-cm with internal irrigation  
 DASK Drill #6 : Drill speed 800 to 1,200 rpm, 30~45N-cm with external irrigation

## Stoppers | for XRT332035, XRT372035, XED331035D



[Unit: mm, Scale 1 : 1 / mm]

Drilling Depth	L	REF
<b>08</b>	10.6	XFDST <b>08</b>
<b>06</b>	12.6	XFDST <b>06</b>
<b>04</b>	14.6	XFDST <b>04</b>
<b>02</b>	16.6	XFDST <b>02</b>

### Sinus Bur Kit

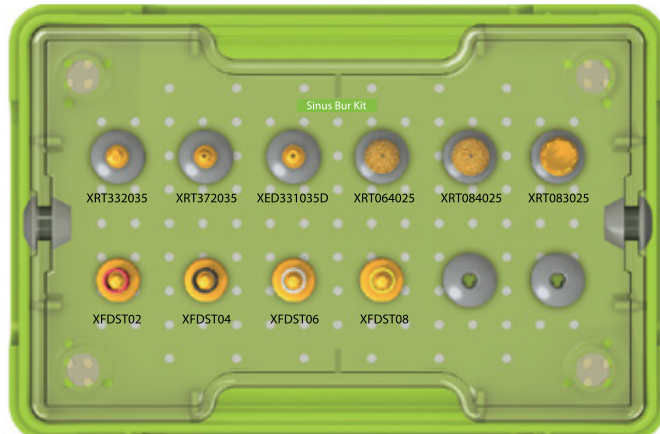

SDK

### Sinus Elevation Instruments

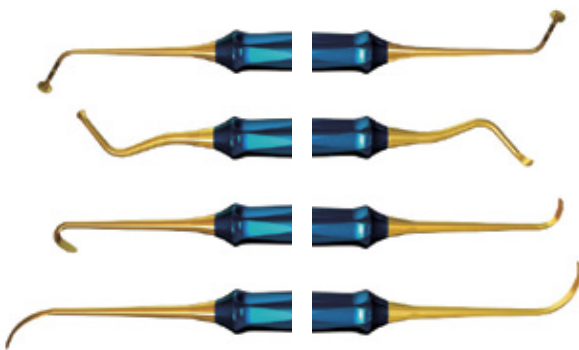

[Scale 1 : 0.68 / mm ]

REF	XSE1L
REF	XSE2L
REF	XSE3L
REF	XSE4L

### Drills for Crestal Approach



DASK Drill #1  
XRT332035



DASK Drill #2  
XRT372035

[800~1,200 rpm]



DASK Drill #3  
XED331035D

[800~1,200 rpm]

The distance from the alveolar crest to the sinus floor should be measured on x-rays prior to surgery. Site preparation is performed with final drills in sequence up to 1mm short of the sinus floor. Then **DASK Drill #1** or **#2** is used and the sinus floor is carefully approached with light apical pressure. When you feel the yielding of the sinus floor, remove the drill. Or, partial preparations with **DASK Drill #1** or **#2** and up-fracture with osteotomes can be performed.

When the sinus cavity is accessed, **DASK Drill #3** is introduced and a much broader detachment from the sinus floor can be facilitated horizontally with hydraulic pressure thanks to the internal irrigation hole.

**DASK Drill #3** can also be used for a lateral approach surgery.

\* The internal irrigation not only provides a cooling effect, but also adds hydraulic pressure to slightly lift the sinus membrane during drilling.

## Drills for Lateral Approach



DASK Drill #4  
XRT064025



DASK Drill #5  
XRT084025

**[800~1,200 rpm]**



DASK Drill #6  
XST083025

**[800~1,200 rpm]**

To make a lateral window through the antrum (thin-out) approach.

\* DASK Drill #4 or #5 is used to prepare a lateral sinus window using light pressure and rotating strokes. The DASK Drill #4 or #5 is designed to minimize the risk of sinus membrane perforation.

To make a lateral window through the wall-off technique.

\* DASK Drill #6 is used to cut and detach a bony island like a trephine bur from the lateral wall. Uncontrolled overdrilling may lead to sinus perforation and possible damage to the membrane. External irrigation is necessary when drilling.

## DASK Maintenance

### Sterilization and Instrument Care Procedures

- Please follow for legal regulations, as well as hygienic guidelines to prevent contamination and infection.
  - Please remember that you are responsible for the maintenance and sterility of your medical/dental products/device.
  - It is important to use and follow, proper cleaning, disinfection and sterilization procedures.
  - It is also important to follow the manufacturer's recommendation on use of drills.
  - Please keep a log as to how many times the drills were used.
  - Drill usage is determined by surgical site not per patient. Bone density and usage determine the life of the drills.
  - Drills should be considered for replacement after approximately 15- 20 uses based on bone density. Check drills frequently for wear.
1. All instruments, immediately after use, must be presoaked for a few minutes in a germicidal bath to loosen and prevent debris from attaching to instruments. Do not soak overnight.
  2. Scrub with a soft brush to remove any debris.
  3. For internal irrigation drills, use a reamer or small gauge needle to internally cleanout the drills.
  4. Before using an ultrasonic cleaner, wrap drills in a 2 x 2 gauze to prevent rubbing against each other.
  5. Rinse thoroughly with warm water.
  6. Clean all instrument trays with a germicidal cleaner prior to replacing instruments in kit.
  7. Dry completely and place back into kit.
  8. Always check for damage or corrosion after rinsing and drying.
  9. Seal the tray in a sterilization pouch.
  10. Sterilize using a steam autoclave in 121°C/250F for 30 minutes or refer to manufacturer's recommendations.
  11. Store in a dry area at room temperature.

### Crestal Approach (Sinus Lifting)

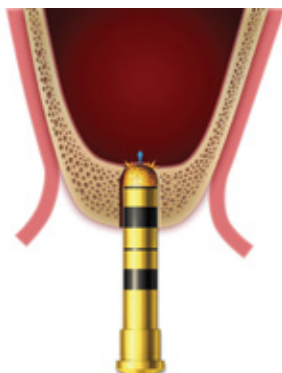

After Ø3.8 Final drilling, eliminate the residual bone (1mm) using a DASK Drill #1 or #2 (in hard bone) until you feel a slight drop.

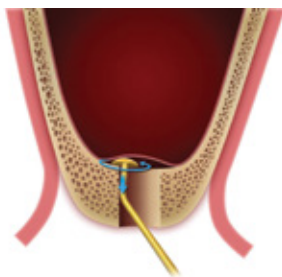

Detach sinus membrane using the dome-shape sinus curette.

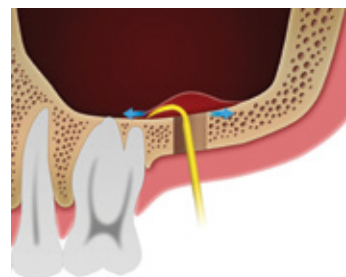

Detaching the sinus membrane to create adequate space for graft material.

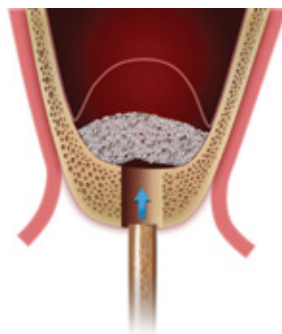

Fill the sinus cavity with [\[OSTEON™ Lifting\]](#) graft material.

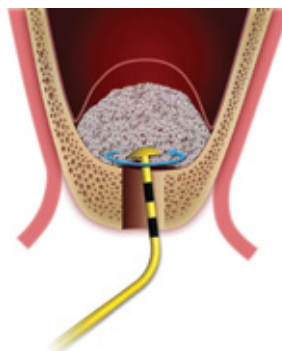

Fill and distribute [OSTEON™](#) graft material evenly throughout the achieved space.

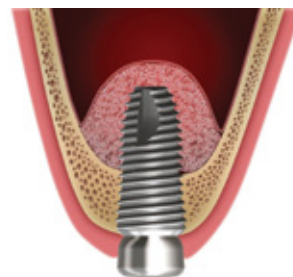

Placement of implant into the osteotomy

## Lateral Approach (Sinus Elevation)

### Wall-off Technique

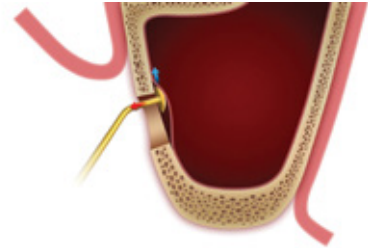
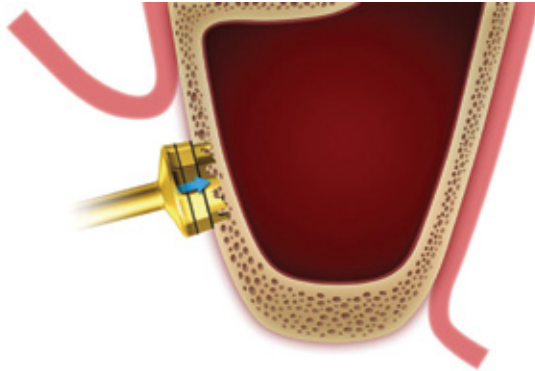

Detach sinus membrane using the dome-shape sinus curette.

DASK Drill #6 is used to cut a round bony island from the lateral wall like a trephine bur. Start to drill at a desired location and proceed until you see the shadow of the sinus membrane. Then, separate and lift the bony island up from the neighboring wall with a molt curette or a periosteal elevator. The bony island is repositioned back in its original position after bone augmentation.

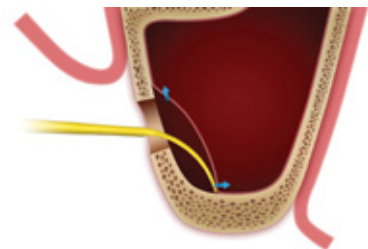

Elevate the sinus membrane to create adequate space for graft material.

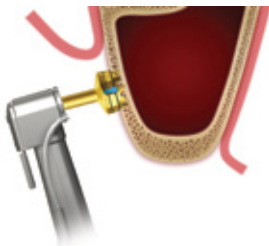

The first laser mark is 1.5mm and the second is 3.0mm. Overdrilling can cause sinus perforation and possible damage to the membrane.

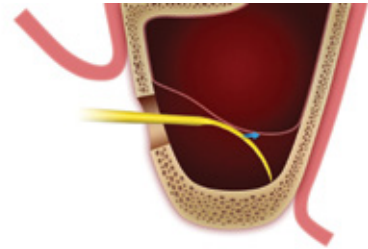

Elevate the sinus membrane to create adequate space for graft material.

### Thin-out Technique

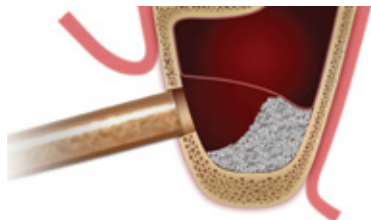
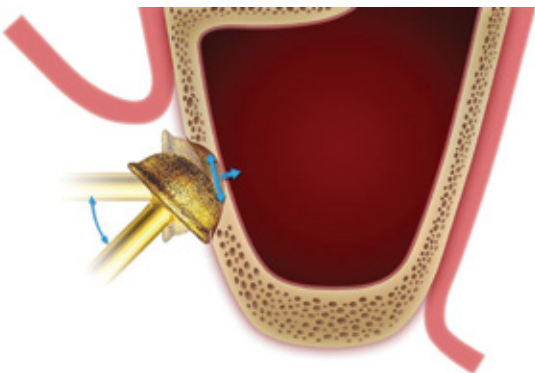

Fill the obtained space with [OSTEON™ Sinus] graft material.

Thin down the lateral wall with DASK Drill #4 or #5 at a 45 degree angle to reach the Schneiderian Membrane.

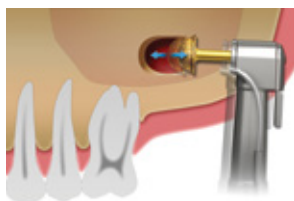

Move the DASK Drill #4 or #5 mesiodistally with a gentle pressure until you get the desired shape and size of the window for bone augmentation.



The bony island can be repositioned after bone augmentation. Implant placed (SuperLine).



# Osteotome Kit

- Osteotomes compress the bone laterally, providing denser bony interface rather than removing valuable bone from the surgical site.

## Osteotomes | Final drill type

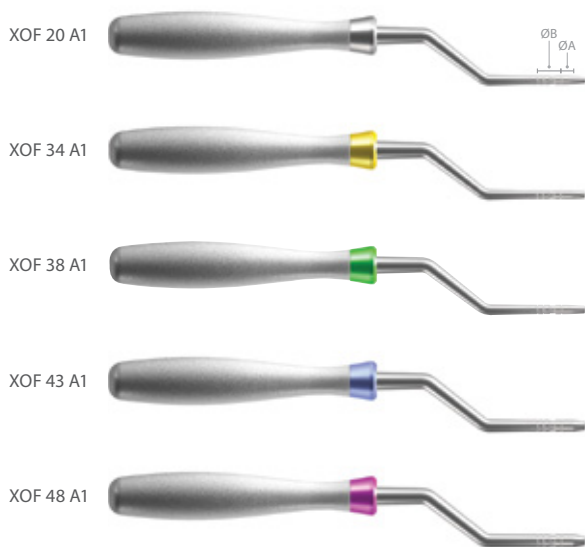

[ Unit: mm, Scale 1 : 0.4 / mm ]

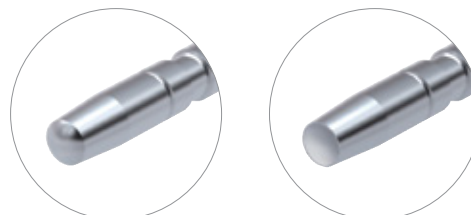

**Type A**  
(Convex)

**Type B**  
(Concave)

Type	Art No	ØA	ØB
<b>A</b> (Convex)	XOFK 20 A1	Ø1.7	Ø2.8
	XOFK 34 A1	Ø2.3	Ø2.8
	XOFK 38 A1	Ø2.7	Ø3.2
	XOFK 43 A1	Ø2.8	Ø3.8
	XOFK 48 A1	Ø3.0	Ø4.3
<b>B</b> (Concave)	XOFK 20 B1	Ø1.7	Ø2.8
	XOFK 34 B1	Ø2.3	Ø2.8
	XOFK 38 B1	Ø2.7	Ø3.2
	XOFK 43 B1	Ø2.8	Ø3.8
	XOFK 48 B1	Ø3.0	Ø4.3



# Sinus Elevator

- Makes the sinus lift easy and drastically reduce the possibility of membrane perforation.
- Balloon expansion of 0.5cc saline equals 6mm of membrane elevation.



Type	Art. No.
Including Syringe	GSB38
Balloon Only	GSB38B

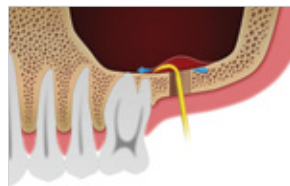
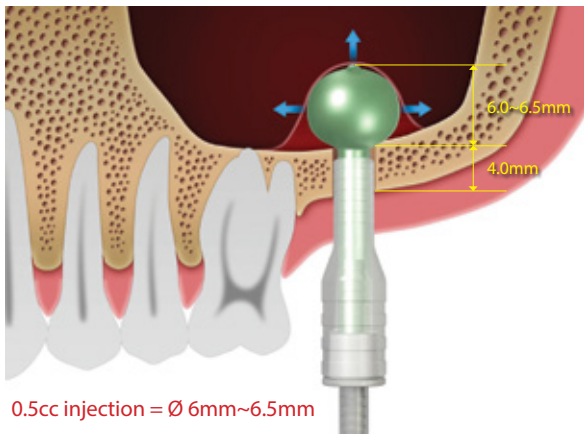
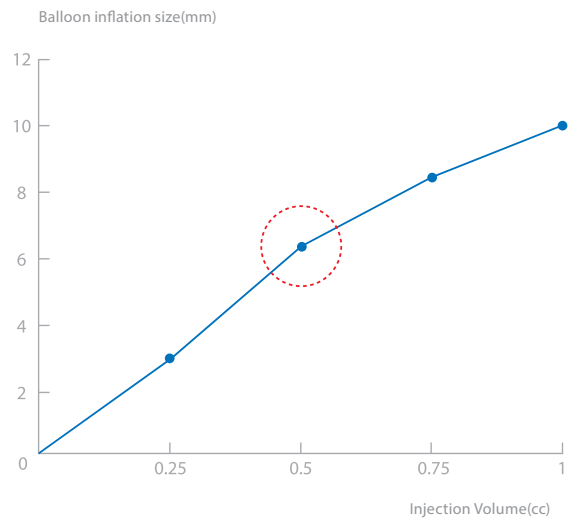

Detach the sinus membrane to create adequate space for graft material.

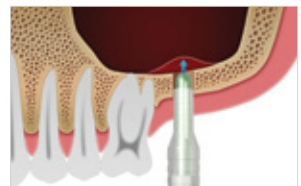

Carefully insert the Sinus Elevator into the osteotomy.

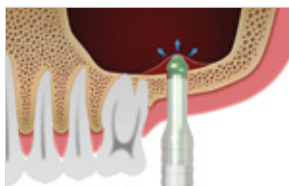

Expand the balloon progressively.

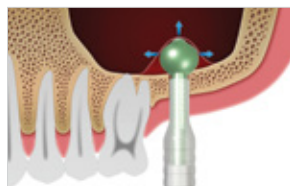

Elevate the sinus membrane through the balloon inflation.



Use [OSTEON™ Lifting] graft material to fill the sinus cavity.



Placement of implant in the osteotomy.

# GBR Instruments

*RS Kit  
Harvest Drill*

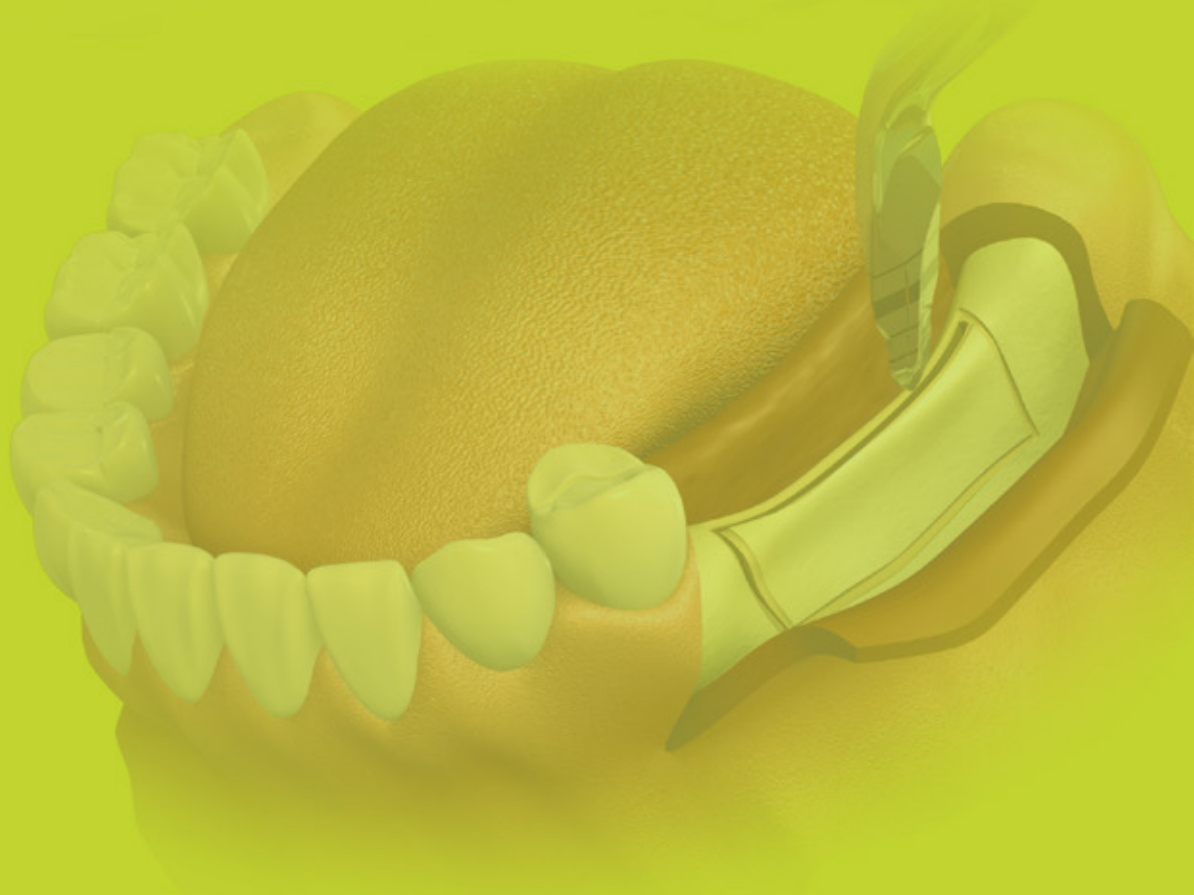

# Ridge Spreader (RS) Kit

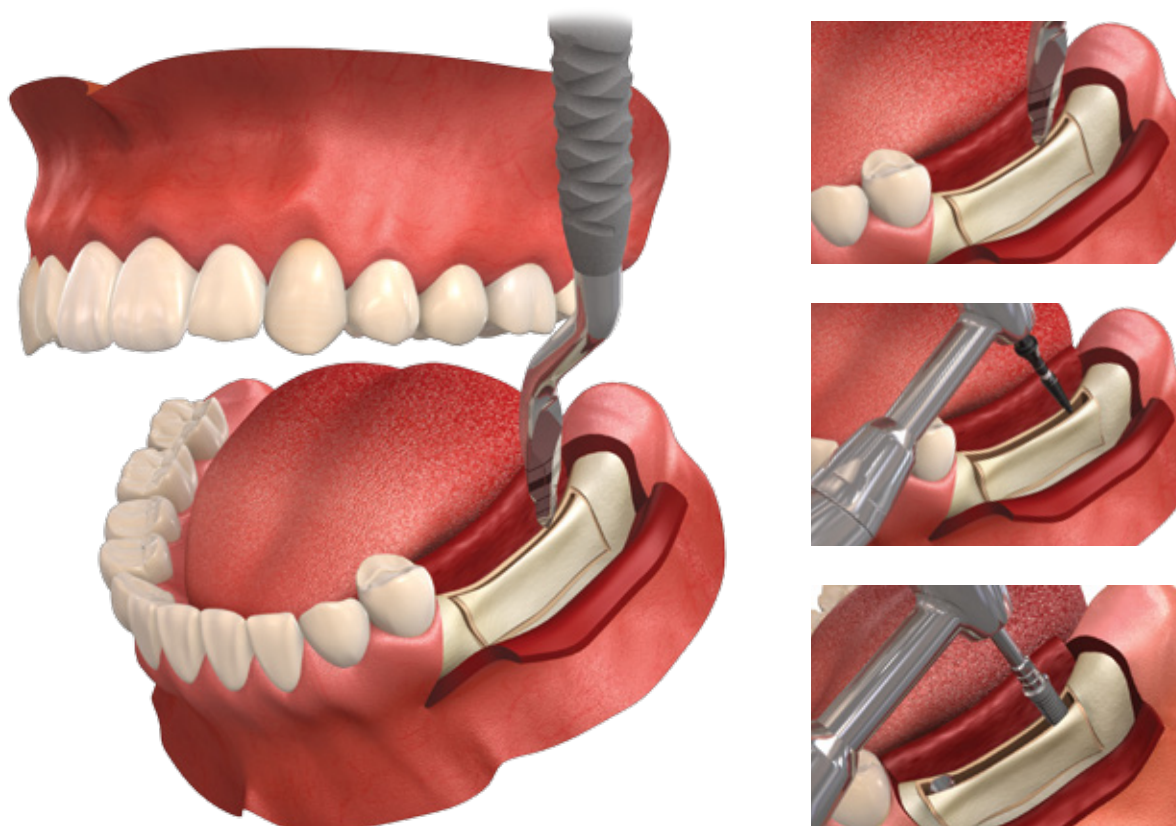

- Allows the achievement of space for implantation through the spreading of the bone with chisel and without drilling
- There are three types of Ridge Spreaders to create space up to Ø4.5
- Convenient surgeries due to the compatibility with hand-piece and ratchet
- Easy-to-use kit component

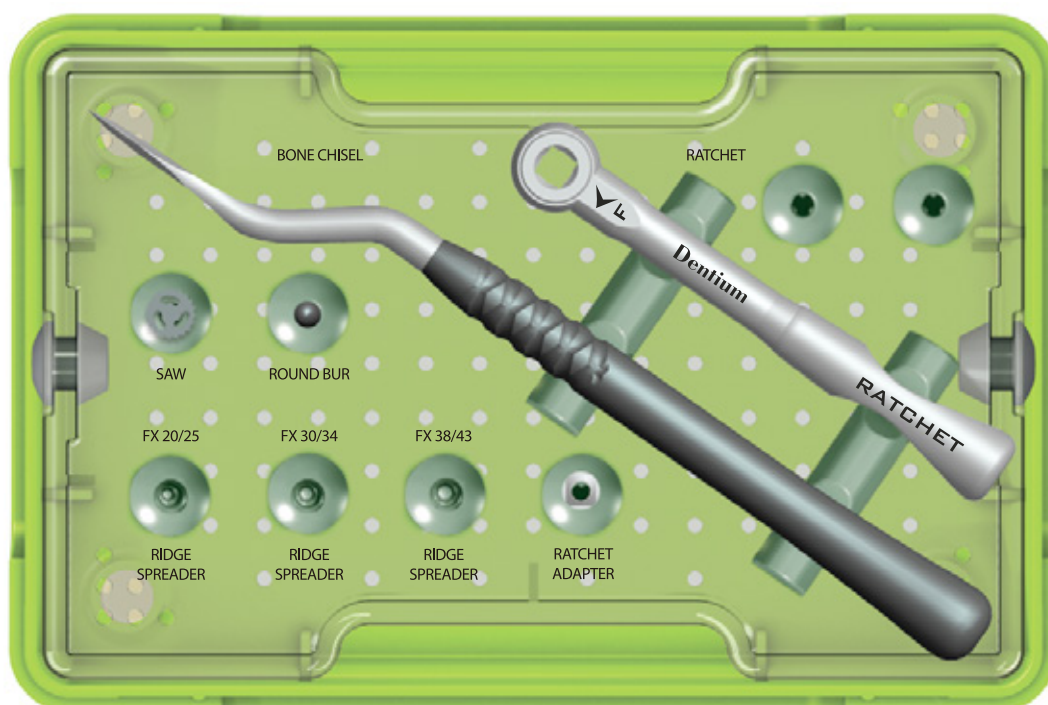



XRSK

**Kit contents**

Bone Chisel		XBC305013
Ratchet		XRCA1
Ridge Spreader Drills		RS142435
		RS203235
		RS263635
Round Bur		RS263635
Ratchet Adapter		XRA3917
Mini Saw		XDS8025

### Bone Chisel



Art. No.	XBC305013
----------	-----------

### Ratchet



Art. No.	XRCA1
----------	-------

[Unit: mm, Scale 1 : 0.6 / mm]

### Ridge Spreader Drills

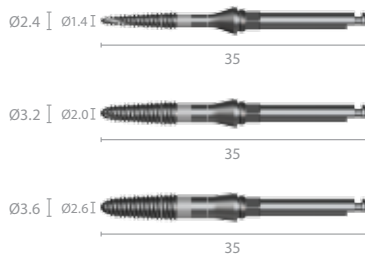

Diameter	L	Art. No.
$\varnothing 1.4$ / $\varnothing 2.4$	35	RS142435
$\varnothing 2.0$ / $\varnothing 3.2$	35	RS203235
$\varnothing 2.6$ / $\varnothing 3.6$	35	RS263635

### Round Bur



Diameter	L	Art. No.
$\varnothing 4.0$	35	XRB4035

### Ratchet Adapter



Art. No.	XRA3917
----------	---------

### Mini Saw

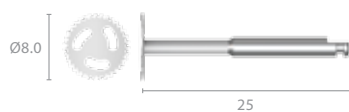

Diameter	L	Art. No.
$\varnothing 8.0$	25	XDS8025

[Unit: mm, Scale 1 : 1 / mm]

**RS Kit + NR Line + OSTEON™ II + Collagen Membrane**

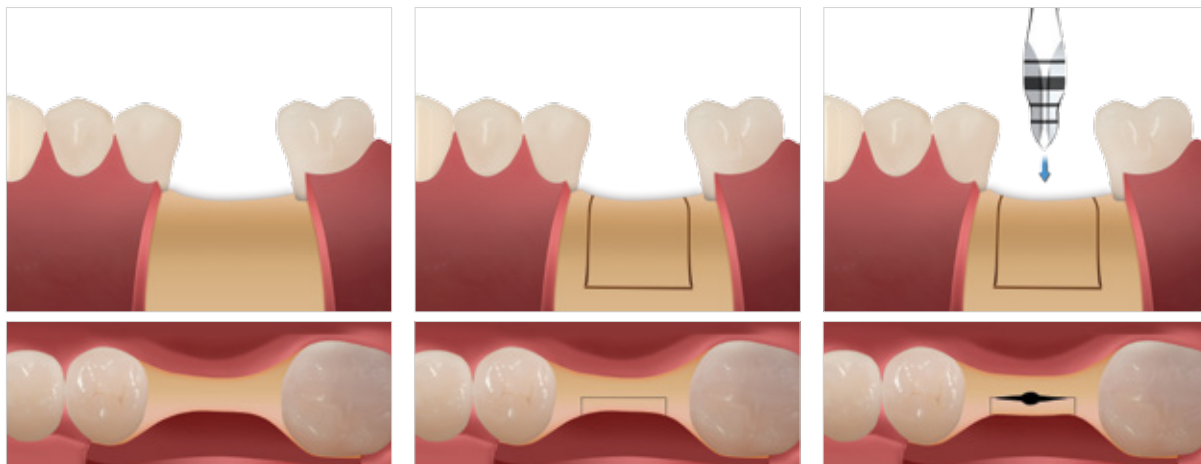

Incision

Decortification

Expansion with Bone Chisel

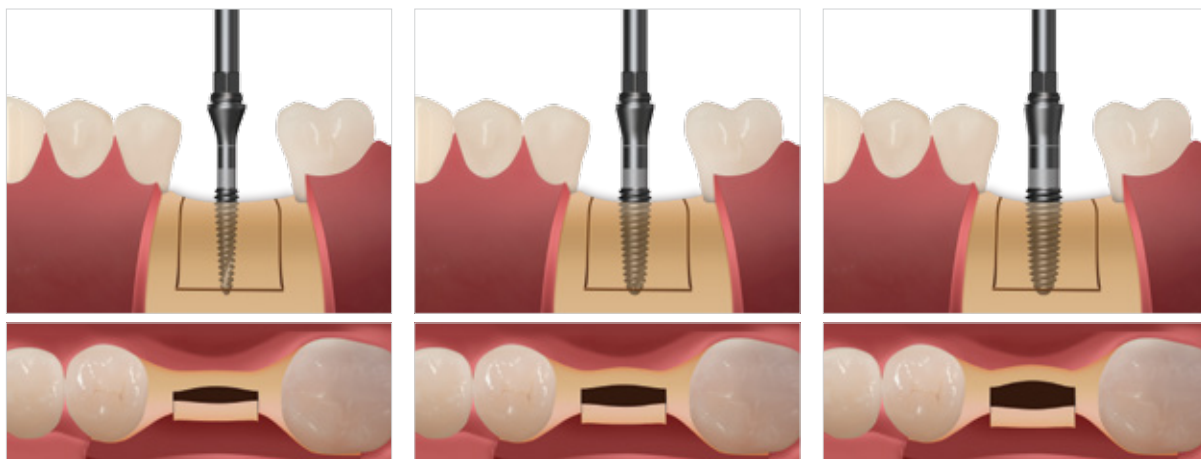

Expansion with Ridge Spreader (20~60rpm / 30~45 N-cm) - Expanding alveolar bone ridge to make space for fixture

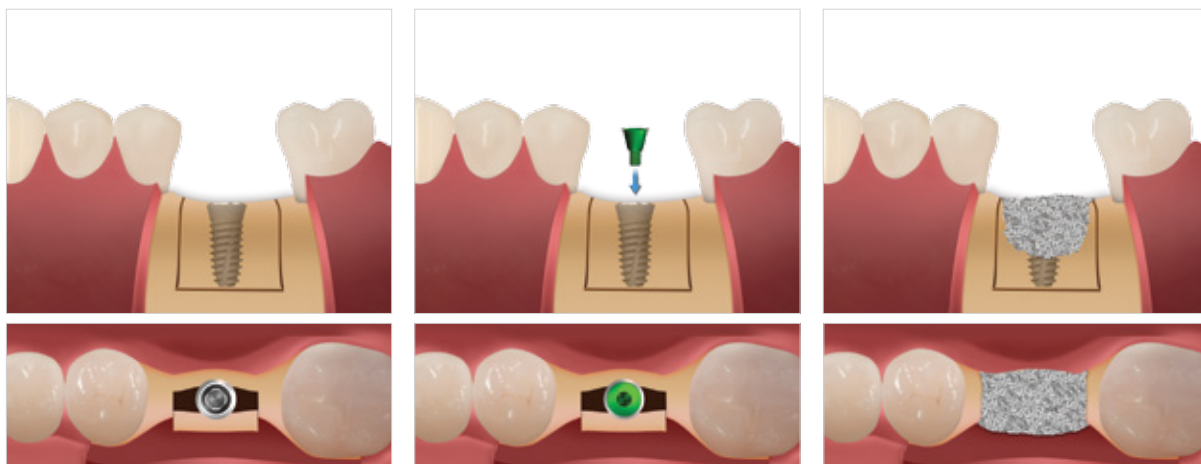

Fixture placement  
NR Line

Cover Screw connection

Application of graft material  
OSTEON™ II



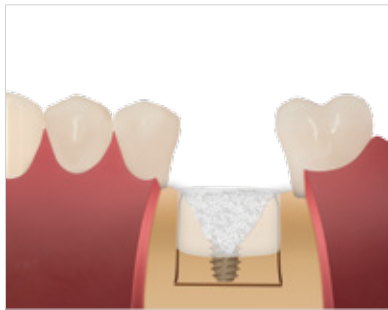

Barrier membrane application  
Collagen Membrane

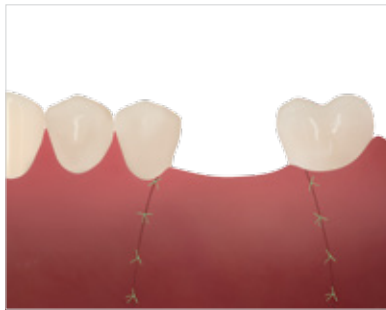

Suture

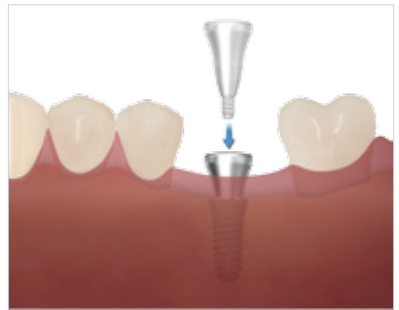

Healing Abutment connection

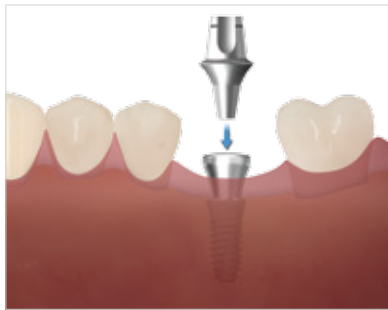
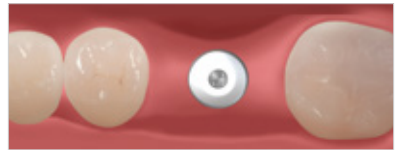
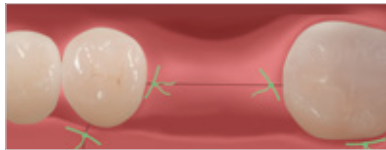
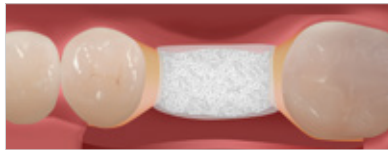

Dual Abutment connection

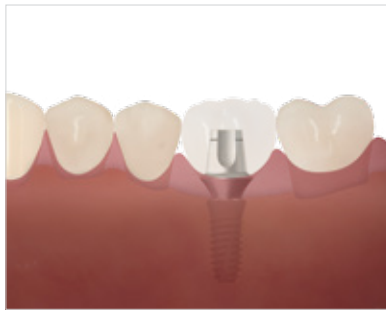

Final prosthesis

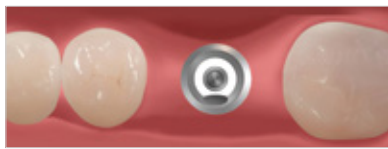

# Harvest Drill

Collect autogenous bone and prep osteotomy simultaneously and effectively using the specially designed drills, the Harvest Drills.

- Sharp, pointed tip to prevent drill chattering for precise drilling.
- Drill stoppers applicable to control the depth of the drilling for safe and efficient bone harvesting, especially in the buccal side of the ridge.
- Recommended drill speed of less than 100 rpm / 50N-cm helps preserve the vital autogenous bone.
- Excellent clinical results may be achieved when harvested autogenous bone is combined with Osteon™ II.

## Harvest Drills

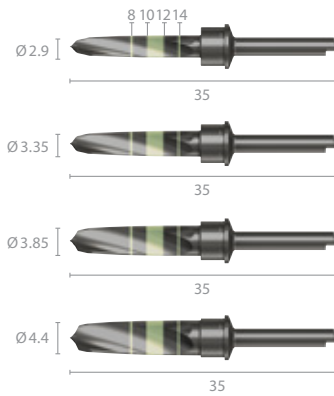

Diameter	L	Art. No.
Ø2.9	35	XFH 34 35
Ø3.35	35	XFH 38 35
Ø3.85	35	XFH 4335
Ø4.4	35	XFH 48 35

## Harvest Drill Stopper

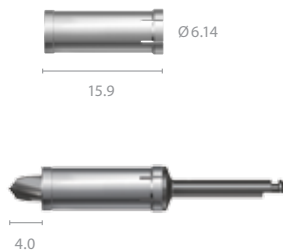

L	Art. No.
15.9	XFHST04

## First Guide Drill



Diameter	L	Art. No.
Ø2.2	35	XFH 22 35

## Second Guide Drill



Diameter	L	Art. No.
Ø2.6	35	XFH 26 35

[ Unit: mm, Scale 1 : 1 / mm ]

\* Bone collection in the buccal side of ridge: 50~200rpm / 30~50N-cm



## Final Drill

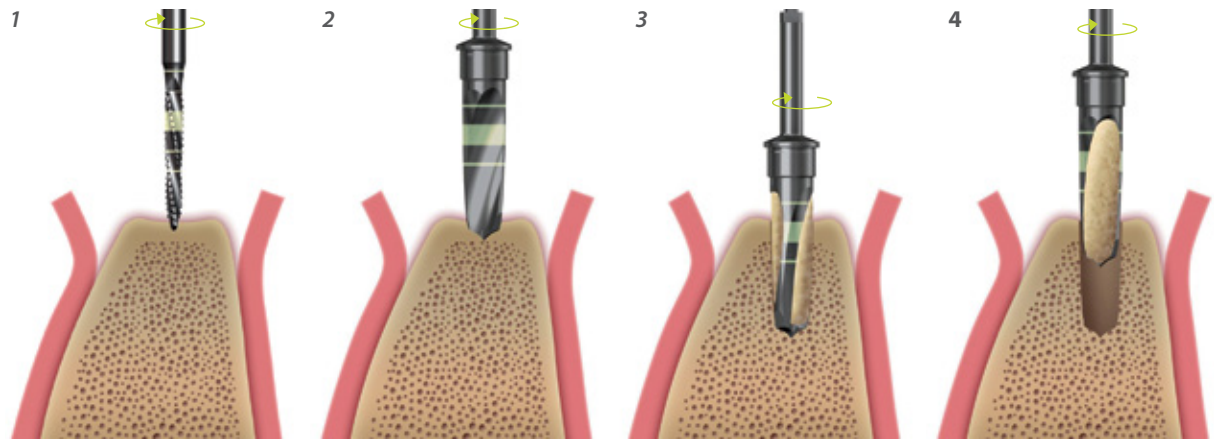

1 - First Guide Drill  
1000 rpm/30~45N-cm with irrigation

2 ~ 4 - Harvest Drill  
30~100 rpm/30~50N-cm without irrigation

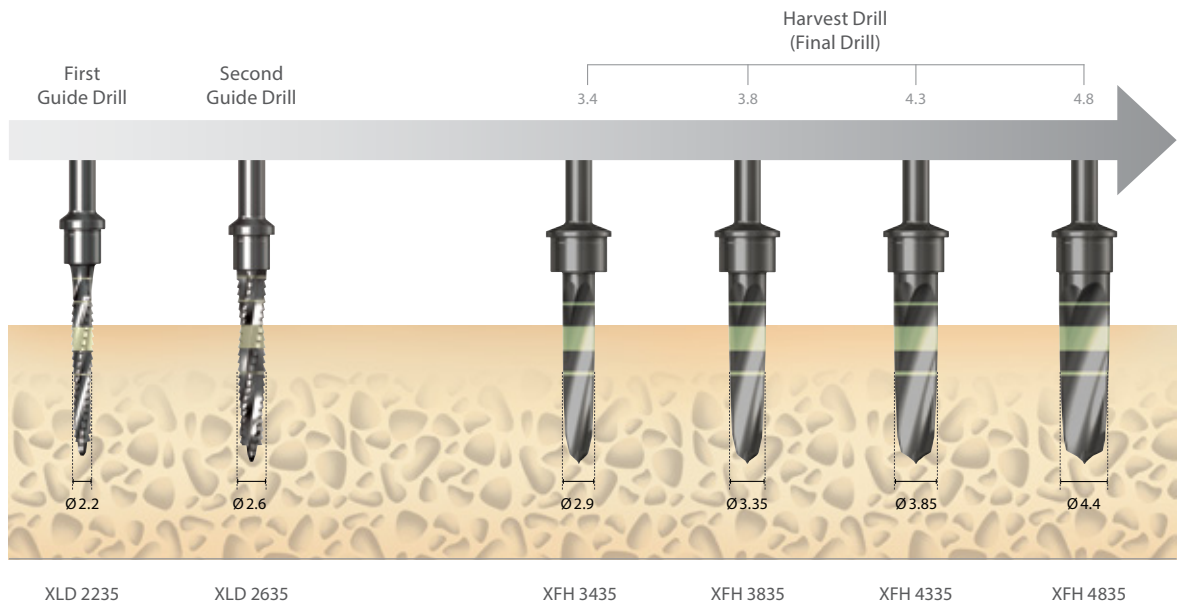

\* During the 4.3/4.8 fixture insertion into the bone density of D3~D4, the 3.35/3.85 harvest drilling process can be skipped.

# Others

*Help Kit*  
*Temporary Shell*  
*White Seal*

# Help Kit

- Easy solution for critical problems which may occur in the prosthetics process
- 5 tools in 1 kit (Screw Remover / Abutment Hex Remover / Screw Tap Repair Fixture Remover / Cover & Abutment Screw Remover)
- Compatible with most dental implant products now available on the global market
- Heavy duty with robust design and proven materials

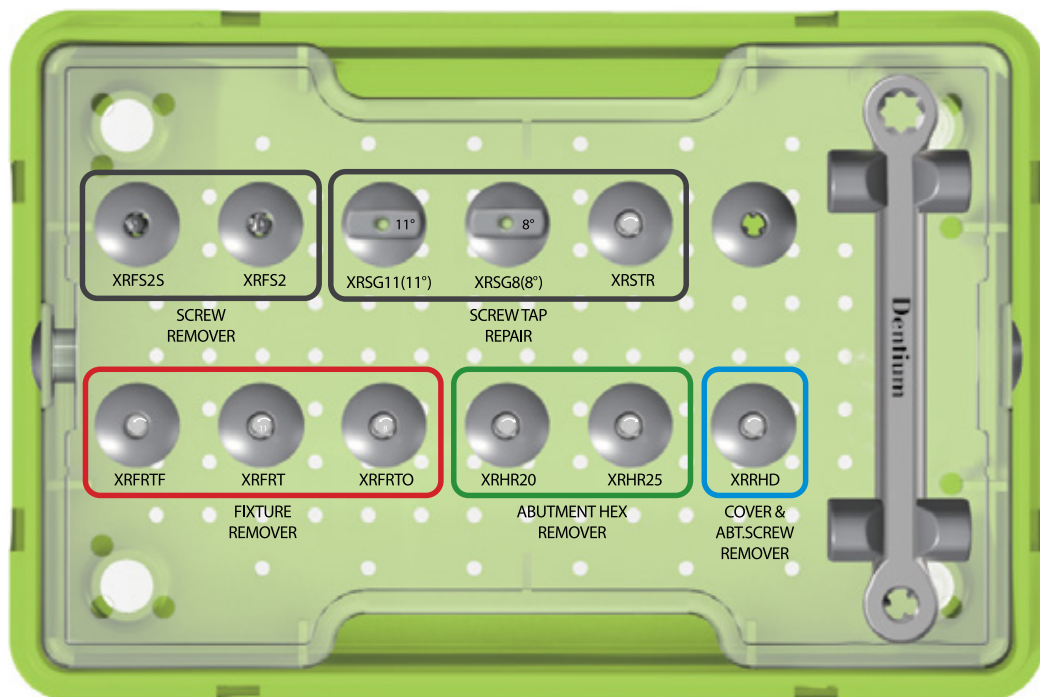

XIH

## Screw Remover

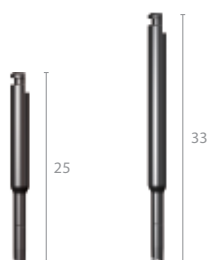

L	Art. No.
25	XRF S2S
35	XRF S2

## Abutment Hex Remover

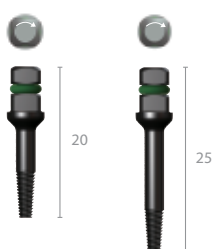

L	Art. No.
20	XRHR 20
25	XRHR 25

### Screw Tap Repair



Type	Art. No.
Tap	XRSTR
11° Guide	XRSG11
8° Guide	XRSG8

### Fixture Remover

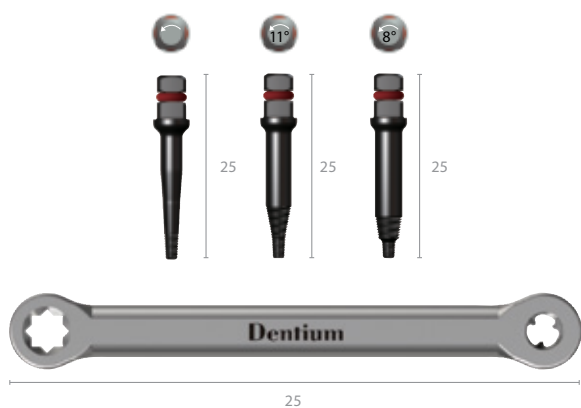

Type	Art. No.
Remover	XRFRTF
	XRFRTO
	XRFRW
Wrench	XRFRW

### Cover & Abutment Screw Remover



L	Art. No.
25	XRRHD

## Screw Remover

### Application

To remove the remaining screw when the abutment screw is broken inside the fixture.

### Advantage

Easy to remove the broken screw, as well as protect the internal threads of the fixture from being damaged.

### Usage

1. Set the torque of the implant motor to 30~50 rpm in a CCW (counterclockwise) direction.
2. Assemble the tool with the hand-piece.
3. Run the motor while keeping the tip of the tool appropriately contacted with the broken screw until successfully removed.

**\*Caution: Do not overload the tool with pressure; apply moderate pressure.**

1

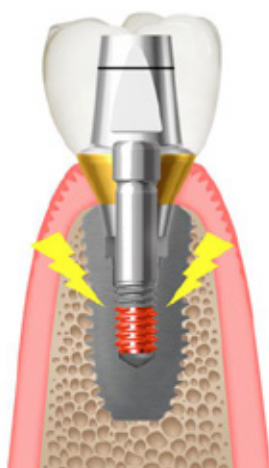

Dual Abutment

2

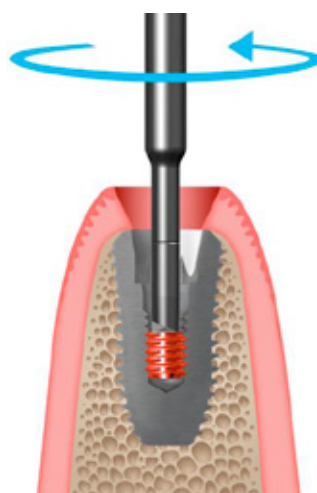

Use the friction force of the tool rotating counterclockwise to remove the screw.

Hand-piece torque: 30~50rpm / Reverse

3

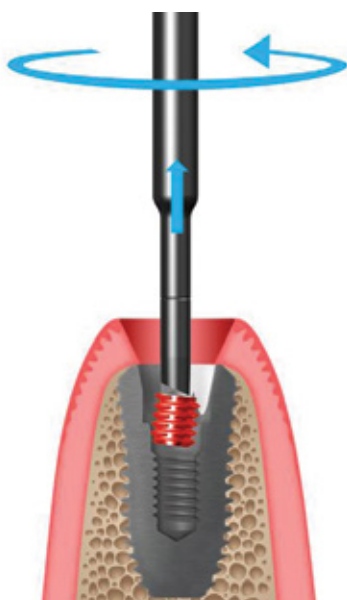

Allow the screw to gradually come out in a swaying motion.

4

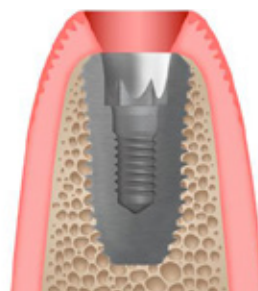

## Abutment Hex Remover

### Application

To remove the remaining hex when the hex portion of an abutment is broken.

### Advantage

Easy to remove the broken hex, as well as protect the internal threads of the fixture from being damaged.

### Usage

1. Insert the tool inside into the remaining hex hole of the fixture inside.
2. Assemble the ratchet with the tool and rotate it in a CW (clockwise) direction to lock the tool tip with the remaining hex.
3. Disengage the ratchet and remove the remaining hex by gently rocking the tool.
4. If necessary, the hole located in the upper portion of the tool may be used with the crown ejector (not included).

**\*Caution: Do not overload the tool with pressure; apply moderate pressure.**

1

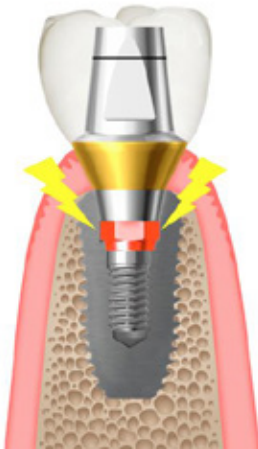

Dual Abutment (Hex)

2

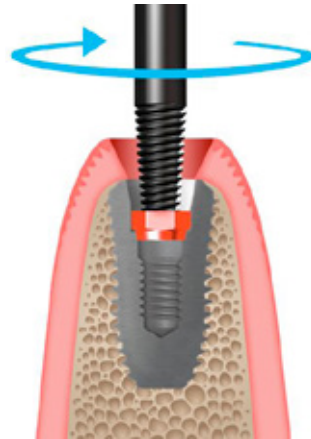

Rotate the tool clockwise so that the remaining hex gets tightly engaged to the tool.

3

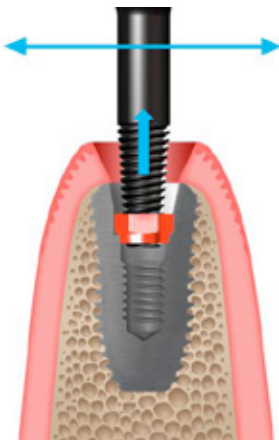

Once the tool is tightly locked to the hex remnant, disengage the ratchet. Gently rock the tool until the hex is successfully removed.

4

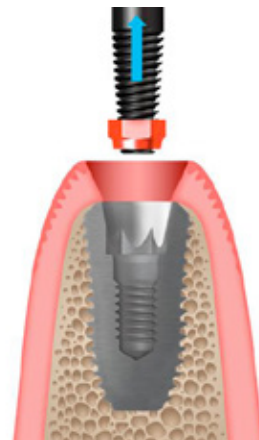

## Screw Tap Repair

### Application

To recreate the internal thread lines of the fixture when it is damaged.

### Advantage

Easy to recreate the internal threads with the help of the guides corresponding to different internal angulation (8, 11 degrees) of the fixture.

### Usage

1. Place the guide with corresponding degree to the fixture.
2. Assemble the tap tool with ratchet.
3. Start tapping using the tap tool with appropriate torque.
4. If excessive debris accumulates, pause tapping and remove using suction.
5. Repeat steps 3 and 4 until completed.

**\*Caution: Do not apply excessive torque onto the tap tool.**

It is highly recommended to use the ratchet after the initial engagement of the tool and the internal threads.

1

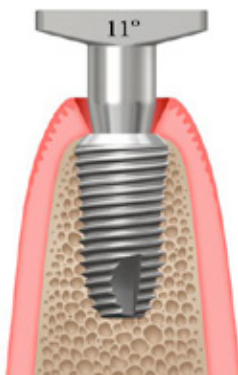

IMPLANTIUM / SuperLine 11°



SimpleLine II 8°

3



Tap with the guide attached.

4



Remove the tool and the guide to suction the debris.

**\*If excessive debris accumulates, pause tapping and remove using suction.**

## Fixture Remover

### Application

To remove the fixture when critically damaged with no other recovery options.

### Advantage

Easy to remove the failed fixture without causing damage to the adjacent bone

### Usage

1. Assemble the tool with ratchet, and insert it into the failed fixture to be removed.
2. Gently rotate the ratchet in a CCW direction until the tool is tightly locked into the fixture.
3. Continue to rotate the ratchet with greater torque in a CCW direction until the failed fixture is completely removed.
4. Separate the tool from the removed fixture by rotating it in a CW direction. If necessary, use the wrench (included) to hold the fixture while rotating the tool with ratchet in a CW direction.

**\*Caution: Sufficient irrigation should be applied to the tool to prevent excessive heating during the procedure.**

1 Art No. XRFRT



IMPLANTIUM / SuperLine 11°

Art No. XRFRT0



SimpleLine II 8°

2~3



Rotate the tool in a counter clockwise direction until it is tightly locked into the fixture. Continue to rotate with additional torque until the failed fixture is completely removed.

4



Separate the tool from the fixture using the ratchet and the wrench that are included in the kit.



## Cover & Abutment Screw Remover

### Application

To disengage the cover screw, healing abutment and abutment screw from the fixture when the 1.28 hex on the head is stripped or damaged.

### Advantage

Easy to disengage the cover screw, healing abutment and abutment screw with stripped or damaged hex.

### Usage

1. Assemble the tool with the ratchet and place it over the damaged 1.28 hex of the cover screw, healing abutment or abutment screw that needs to be removed.
2. Gently rotate the ratchet in a CCW direction to tightly engage the tapered top of the tool into the damaged 1.28 hex.
3. Continue to rotate the ratchet in a CCW direction with greater torque until the cover screw, healing abutment or abutment screw is completely removed.
4. After the removal, rotate the ratchet in a CW to separate the tool and the removed component.

1 Cover Screw

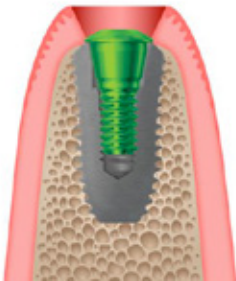

2 Loading downward



Rotate the tool counterclockwise until tightly locked into the 1.28 hex of the cover screw.

3 Abutment Screw

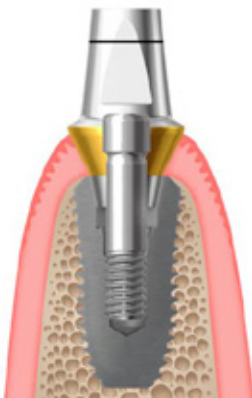

4 Loading downward

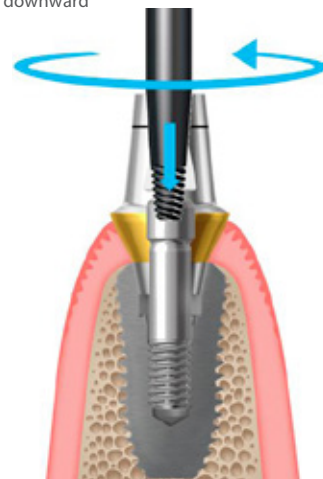

Rotate the tool counterclockwise until tightly locked into the 1.28 hex of the abutment screw.

# Temporary Shell

## Preformed Temporary Crown

- Esthetic appearance that mimics a natural tooth
- Convenient for both single and multi-unit restoration

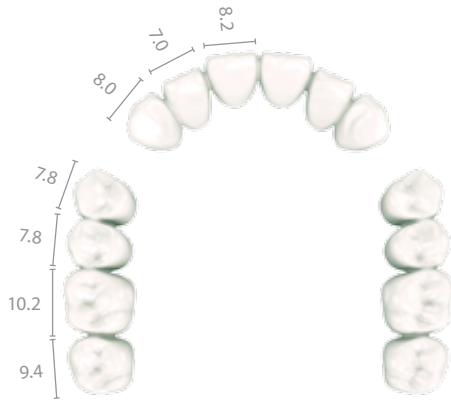

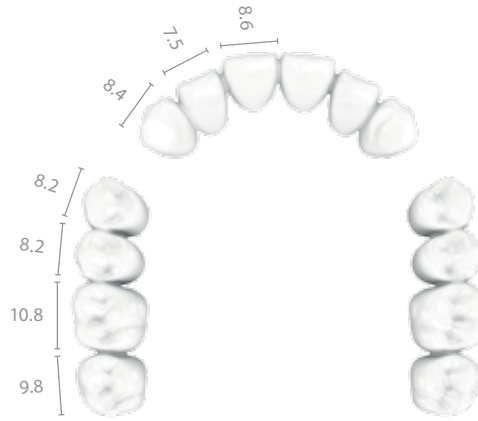

A2 Shade

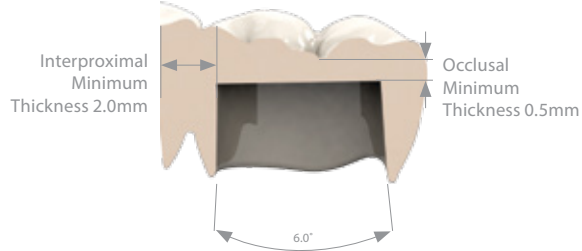
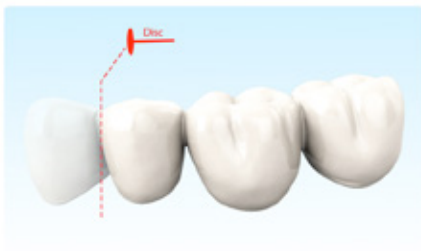
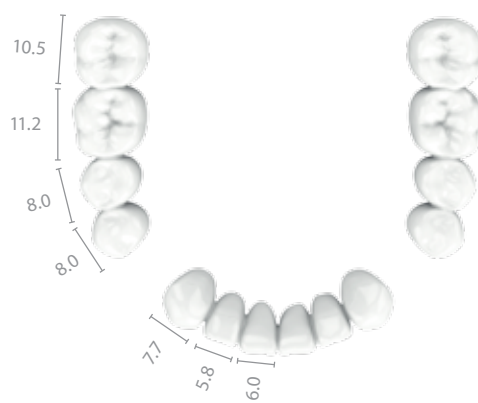
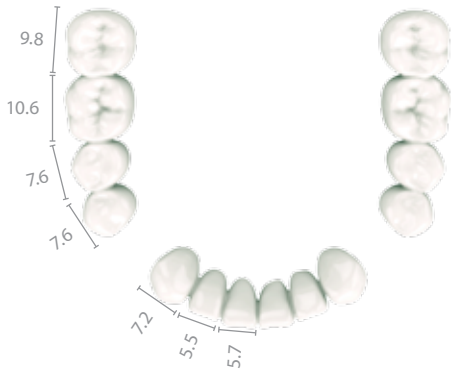

Transparent



Shade		Type	REF
	A2	Regular	TSA2-R
		Wide	TSA2-W
		Full set	TSA2-FS
	Transparent	Regular	TSTR-R
		Wide	TSTR-W
		Full set	TSTR-FS
	Regular	Regular	TS-R
		Wide	TS-W
		Full set	TSFS

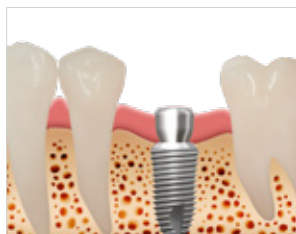

Healing

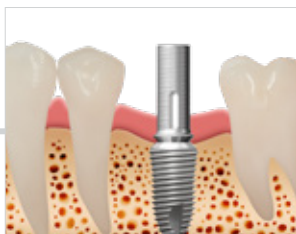

Temporary Abutment Connection

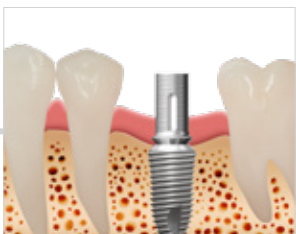

Temporary Abutment Preparation

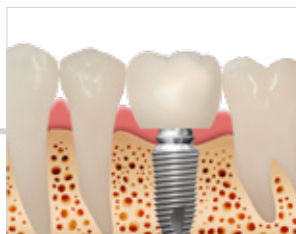

Temporary Shell Try-In

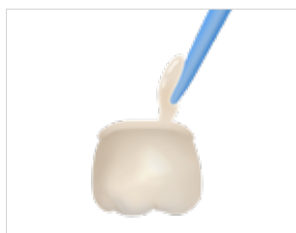

Filling of the Temporary Shell with Acrylic Resin

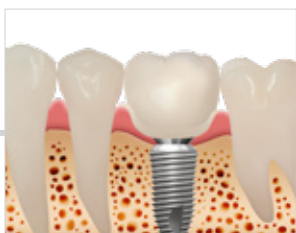

Placement of Temporary Shell

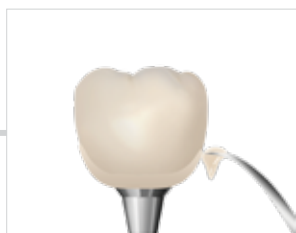

Contouring of the Cervical Crown Margin

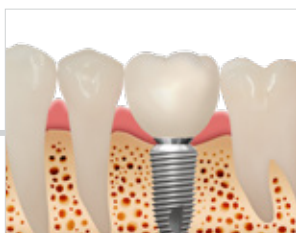

Placement of Temporary Shell



Healing



Temporary Abutment Connection



Temporary Shell Try-In



Filling of the Temporary Shell with Acrylic Resin



Acrylic Resin Setting



Contouring of the Cervical Crown Margin



Contoured Restoration



Provisional Restoration

# White Seal

### Easier Filling and Removal

- Unlike the conventional cotton or impression material, the plush material allows a greater user-friendliness during dental procedures.

### No odor & color change

- Odor and color changing problem seen in Silicone or other sealing materials is eliminated.

### Stable form maintenance

- The rod with proper stiffness helps maintain its form while preventing the upper application layer from collapsing.

### Easy to Cut into Desired Size

- White Seal™ is available in 30mm (length) size. The user may easily cut off the desired amount and conveniently store away the rest for later use.

## Color/Odor Change Test



## How to use

Cut off a piece of the White Seal™ in the desired size with a scissor or a knife. Insert the piece into the abutment hole and seal it with a resin material.

(\*It is recommended to submerge the White Seal™ 2.0 mm from the occlusal surface)

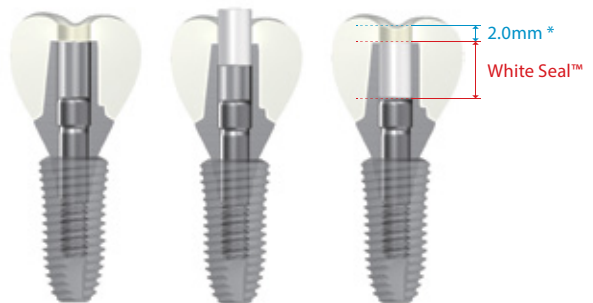

## White Seal



Diameter	Length	Art. No.
Ø1.9	30	AHF 19030
Ø2.3	30	AHF 23030

1 Final prosthesis

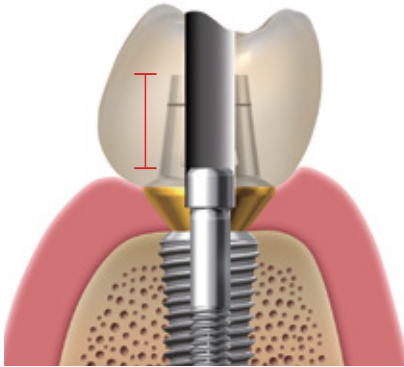

Measure depth

2 White Seal Application

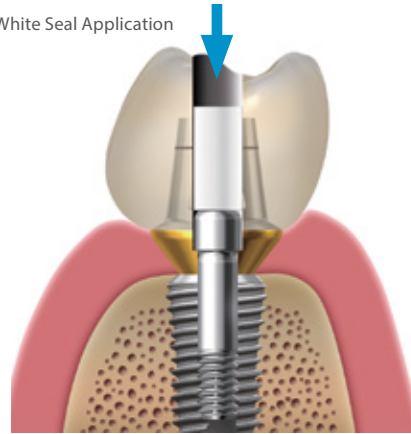

Measure depth  
Place the White Seal™

3 White Seal Application

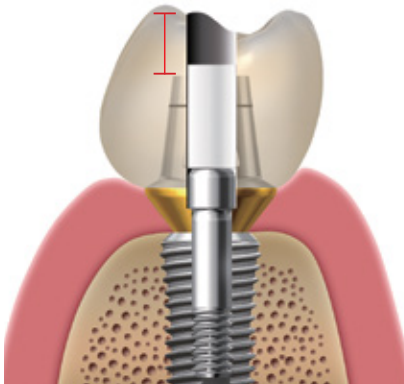

Measure depth  
Place the White Seal™ (2mm downward  
from the crown top)

**White Seal™**



# DENTIUM LONG-TERM CLINICAL DATA

2002

2003

2004

2005

2006

2007

2008



2002. 05. 17  
Pre-op



2002. 09. 04  
Post-op



2003. 03. 15  
Final prosthesis

# Dentium

For Dentists By Dentists

2009

2010

2011

2012

2013

2014

2015

11 YEARS



2008. 04. 14  
5 years

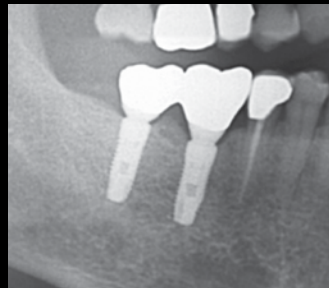

2013. 12. 05  
11 years

over  
**10** years  
of Long  
term  
data

OVER A **DECADE** OF  
COMMITMENT TO  
THE **BEST PRODUCTS**  
FOR DENTISTS AND  
PATIENTS

# Dentium Instruments

for Total Solution

Catalog & Manual

**Dentium**  
For Dentists By Dentists

Specifications are subject to change without notice.  
Some products listed in this catalog are not available in the market due to pending approval.

---

**HEAD OFFICE**

504 Gyeonggi R&DB Center, 105 Gwanggyo-ro, Yeongtong-gu, Suwon-si, Gyeonggi-do, Korea [443-270]

**T** +82-31-888-5441 **F** +82-31-888-5430

**E-mail** biz\_mail@dentium.com / www.dentium.com

INCO-1504 [Rev.1]